

Data sheet

Video recorder LINAX DR2000



Function and system design

Measuring principle	<p>Electronic acquisition, display, recording, analysis, remote transmission and archiving of analog and digital input signals.</p> <p>The device is intended for installation in a panel or cabinet. There is also the option of operating it in a desktop housing or field housing.</p>
Measuring system	<p>Multichannel data recording system with multicolored TFT display (145 mm / 5.7" screen size), galvanically isolated universal inputs (U, I, TC, RTD, pulse, frequency), digital inputs, transmitter power supply, limit relay, communication interfaces (USB, Ethernet, optional RS232/485), optionally available with Modbus protocol, 128 MB internal memory, external SD card and USB stick. An Essential Version of the reporting software is included for SQL-supported data analysis at the PC.</p> <p>i The number of inputs available in the basic device can be individually increased using a maximum of 3 plug-in cards. The device supplies power directly to connected two-wire transmitters. The device is configured and operated via the navigator (jog/shuttle dial), via the integrated web server and a PC, or via an external keyboard. Online help facilitates local operation.</p>
Reliability	<p>Dependability</p> <p>Depending on the device version, the MTBF is between 52 years and 24 years (calculated based on SN29500 standard at 40°C)</p> <p>Serviceability</p> <p>Battery-backed time and data memory. It is advisable to have the backup battery replaced by a service technician after 10 years.</p> <p>Real time clock (RTC)</p> <ul style="list-style-type: none"> ▪ Configurable summer/normal time changeover ▪ Battery buffer. It is advisable to have the backup battery replaced by a service technician after 10 years. ▪ Drift: <10 min./year ▪ Time synchronization possible via SNTP or via digital input. <p>Standard diagnostic functions as per Namur NE 107</p> <p>The diagnostic code is made up of the error category as per Namur NE 107 and the message number.</p> <ul style="list-style-type: none"> ▪ Cable open circuit, short-circuit ▪ Incorrect wiring ▪ Internal device errors ▪ Overage/underrange detection ▪ Ambient temperature out-of-range detection <p>Device error/alarm relay</p> <p>One relay can be used as an alarm relay. If the device detects a system error (e.g. hardware defect) or a malfunction (e.g. cable open circuit), the selected output/relay switches.</p> <p>This "alarm relay" switches if "F"-type errors occur (F = failure), i.e. "M"-type errors (M= Maintenance required) do not switch the alarm relay.</p>

Data sheet

Video recorder LINAX DR2000

Safety

The tamper-proof recorded data are saved and can be transferred to an external SQL database for archiving in a way that prevents subsequent manipulation.

Input

Measured values	<p>Number of analog universal inputs</p> <p>Standard version without universal inputs. Optional input cards (slot 1-3) with 4 universal inputs (4/8/12) each.</p> <p>Number of digital inputs</p> <p>6 digital inputs</p> <p>Number of mathematics channels</p> <p>4 mathematics channels (optional). Mathematics functions can be freely edited via a formula editor.</p> <p>Integration of calculated values e.g. for totalization.</p> <p>Number of limit values</p> <p>30 limit values (individual channel assignment)</p> <p>Function of analog universal inputs</p> <p>You are free to choose between the following measured variables for each universal input: U, I, RTD, TC, pulse input or frequency input.</p> <p>Integration of input variable for totalization e.g. flow rate (m³/h) in quantity (m³).</p> <p>Calculated values</p> <p>The values of the universal inputs can be used to perform calculations in the mathematics channels.</p>
-----------------	---

Measuring range of analog universal inputs	According to IEC 60873-1: An additional display error of ± 1 digit is permitted for every measured value.
--	---

User-definable measuring ranges per universal input of the multifunction card:

Measured variable	Measuring range	Maximum measured error of measuring range (oMR), temperature drift	Input resistance
Current (I)	0 to 20 mA; 0 to 20 mA quadratic 0 to 5 mA 4 to 20 mA; 4 to 20 mA quadratic ± 20 mA Overrange: up to 22 mA or -22 mA	$\pm 0.1\%$ oMR Temperature drift: $\pm 0.01\%/K$ oMR	Load: 50 Ω $\pm 1 \Omega$
Voltage (U) >1 V	0 to 10 V; 0 to 10 V quadratic 0 to 5 V 1 to 5 V; 1 to 5 V quadratic ± 10 V ± 30 V	$\pm 0.1\%$ oMR Temperature drift: $\pm 0.01\%/K$ oMR	$\geq 1 \text{ M}\Omega$
Voltage (U) ≤ 1 V	0 to 1 V; 0 to 1 V quadratic ± 1 V ± 150 mV	$\pm 0.1\%$ oMR Temperature drift: $\pm 0.01\%/K$ oMR	$\geq 2.5 \text{ M}\Omega$

Data sheet

Video recorder LINAX DR2000

Measured variable	Measuring range	Maximum measured error of measuring range (oMR), temperature drift	Input resistance
Resistance thermometer (RTD)	Pt100: -200 to 850 °C (-328 to 1562 °F) (IEC 60751:2008, $\alpha=0.00385$) Pt100: -200 to 510 °C (-328 to 950 °F) (JIS C 1604:1984, $\alpha=0.003916$) Pt100: -200 to 850 °C (-328 to 1562 °F) (GOST 6651-94, $\alpha=0.00391$) Pt500: -200 to 850 °C (-328 to 1562 °F) (IEC 60751:2008, $\alpha=0.00385$) Pt500: -200 to 510 °C (-328 to 950 °F) (JIS C 1604:1984, $\alpha=0.003916$) Pt1000: -200 to 600 °C (-328 to 1112 °F) (IEC 60751:2008, $\alpha=0.00385$) Pt1000: -200 to 510 °C (-328 to 950 °F) (JIS C 1604:1984, $\alpha=0.003916$)	4-wire: $\pm 0.1\%$ oMR 3-wire: $\pm(0.1\% \text{ oMR} + 0.8 \text{ K})$ 2-wire: $\pm(0.1\% \text{ oMR} + 1.5 \text{ K})$ Temperature drift: $\pm 0.01\%/K$ oMR	
	Cu50: -50 to 200 °C (-58 to 392 °F) (GOST 6651-94, $\alpha=4260$) Cu50: -200 to 200 °C (-328 to 392 °F) (GOST 6651-94, $\alpha=4280$) Pt50: -200 to 1100 °C (-328 to 2012 °F) (GOST 6651-94, $\alpha=0.00391$) Cu100: -200 to 200 °C (-328 to 392 °F) (GOST 6651-94, $\alpha=4280$)	4-wire: $\pm 0.2\%$ oMR 3-wire: $\pm(0.2\% \text{ oMR} + 0.8 \text{ K})$ 2-wire: $\pm(0.2\% \text{ oMR} + 1.5 \text{ K})$ Temperature drift: $\pm 0.02\%/K$ oMR	
	Pt46: -200 to 1100 °C (-328 to 2012 °F) (GOST 6651-94, $\alpha=0.00391$) Cu53: -200 to 200 °C (-328 to 392 °F) (GOST 6651-94, $\alpha=4280$)	4-wire: $\pm 0.3\%$ oMR 3-wire: $\pm(0.3\% \text{ oMR} + 0.8 \text{ K})$ 2-wire: $\pm(0.3\% \text{ oMR} + 1.5 \text{ K})$ Temperature drift: $\pm 0.02\%/K$ oMR	
Thermocouples (TC)	Type J (Fe-CuNi): -210 to 1200 °C (-346 to 2192 °F) (IEC 60584:2013) Type K (NiCr-Ni): -270 to 1300 °C (-454 to 2372 °F) (IEC 60584:2013) Type L (NiCr-CuNi): -200 to 800 °C (-328 to 1472 °F) (GOST R 8.585:2001) Type L (Fe-CuNi): -200 to 900 °C (-328 to 1652 °F) (DIN 43710-1985) Type N (NiCrSi-NiSi): -270 to 1300 °C (-454 to 2372 °F) (IEC 60584:2013) Type T (Cu-CuNi): -270 to 400 °C (-454 to 752 °F) (IEC 60584:2013)	$\pm 0.1\%$ oMR from -100 °C (-148 °F) $\pm 0.1\%$ oMR from -130 °C (-202 °F) $\pm 0.1\%$ oMR from -100 °C (-148 °F) $\pm 0.1\%$ oMR from -100 °C (-148 °F) $\pm 0.1\%$ oMR from -100 °C (-148 °F) $\pm 0.1\%$ oMR from -100 °C (-148 °F) Temperature drift: $\pm 0.01\%/K$ oMR	$\geq 1 \text{ M}\Omega$
	Type A (W5Re-W20Re): 0 to 2500 °C (32 to 4532 °F) (ASTME 988-96) Type B (Pt30Rh-Pt6Rh): 42 to 1820 °C (107.6 to 3308 °F) (IEC 60584:2013) Type C (W5Re-W26Re): 0 to 2315 °C (32 to 4199 °F) (ASTME 988-96) Type D (W3Re-W25Re): 0 to 2315 °C (32 to 4199 °F) (ASTME 988-96) Type R (Pt13Rh-Pt): -50 to 1768 °C (-58 to 3214 °F) (IEC 60584:2013) Type S (Pt10Rh-Pt): -50 to 1768 °C (-58 to 3214 °F) (IEC 60584:2013)	$\pm 0.15\%$ oMR from 500 °C (932 °F) $\pm 0.15\%$ oMR from 600 °C (1112 °F) $\pm 0.15\%$ oMR from 500 °C (932 °F) $\pm 0.15\%$ oMR from 500 °C (932 °F) $\pm 0.15\%$ oMR from 100 °C (212 °F) $\pm 0.15\%$ oMR from 100 °C (212 °F) Temperature drift: $\pm 0.01\%/K$ oMR	$\geq 1 \text{ M}\Omega$
Pulse input (I) ¹⁾	Min. Pulse length 40 μs , max. 12.5 kHz; 0 to 7 mA = LOW; 13 to 20 mA = HIGH		Load: 50 Ω $\pm 1 \Omega$
Frequency input (I) ¹⁾	0 to 10 kHz, overrange: up to 12.5 kHz; 0 to 7 mA = LOW; 13 to 20 mA = HIGH	$\pm 0.02\%$ @ f < 100 Hz of reading $\pm 0.01\%$ @ f ≥ 100 Hz of reading Temperature drift: 0.01% of measured value over the entire temperature range	

- 1) If a universal input is used as a frequency or pulse input, a series resistor must be used in series connection with the voltage source. Example: 1.2 k Ω series resistor at 24 V

Maximum load of inputs

Limit values for input voltage and current as well as cable open circuit detection/line influence/temperature compensation:

Measured variable	Limit values (steady-state, without destroying input)	Cable open circuit detection/line influence/temperature compensation
Current (I)	Maximum permitted input voltage: 2.5 V Maximum permitted input current: 50 mA	4 to 20 mA range with disengageable cable open circuit monitoring to NAMUR NE43. The following error ranges apply when NE43 is switched on: $\leq 3.8 \text{ mA}$: underrange $\geq 20.5 \text{ mA}$: overrange $\leq 3.6 \text{ mA}$ or $\geq 21.0 \text{ mA}$: open circuit (display shows: - - - -)
Pulse, frequency (I)	Maximum permitted input voltage: 2.5 V Maximum permitted input current: 50 mA	No cable open circuit monitoring
Voltage (U) >1 V	Maximum permitted input voltage: 35 V	1 to 5 V range with disengageable cable open circuit monitoring: $< 0.8 \text{ V}$ or $> 5.2 \text{ V}$: cable open circuit (display shows: - - - -)
Voltage (U) $\leq 1 \text{ V}$	Maximum permitted input voltage: 24 V	

Data sheet

Video recorder LINAX DR2000

Measured variable	Limit values (steady-state, without destroying input)	Cable open circuit detection/line influence/temperature compensation
Resistance thermometer (RTD)	Measuring current: ≤ 1 mA	Maximum barrier resistance (or line resistance): 4-wire: max. 200 Ω ; 3-wire: max. 40 Ω Maximum influence of barrier resistance (or line resistance) for Pt100, Pt500 and Pt1000: 4-wire: 2 ppm/ Ω , 3-wire: 20 ppm/ Ω Maximum influence of barrier resistance (or line resistance) for Pt46, Pt50, Cu50, Cu53, Cu100 and Cu500: 4-wire: 6 ppm/ Ω , 3-wire: 60 ppm/ Ω Cable open circuit monitoring if any connection is interrupted.
Thermocouples (TC)	Maximum permitted input voltage: 24 V	Influence of line resistance: $< 0.001\%/ \Omega$ Error, internal temperature compensation: ≤ 2 K

Scan rate

Current/voltage/pulse/frequency input: 100 ms per channel

Thermocouples and resistance temperature detector: 1 s per channel

Data storage/save cycle

Selectable save cycle. Choose from: 1s / 2s / 3s / 4s / 5s / 10s / 15s / 20s / 30s / 1min / 2min / 3min / 4min / 5min / 10min / 15min / 30min / 1h

Typical recording duration

Prerequisites for following tables:

- No limit value violation / integration
- Digital input not used
- Signal analysis 1: off, 2: day, 3: month, 4: year
- No active mathematics channels

 Frequent entries in the event log reduce the memory availability!

128 MB internal memory:

Analog inputs	Channels in groups	Storage cycle (weeks, days, hours)				
		5 min	1 min	30 s	10 s	1 s
1	1/0/0/0	668, 4, 14	135, 0, 5	67, 4, 4	22, 3, 20	2, 1, 18
4	4/0/0/0	491, 0, 10	99, 4, 17	49, 6, 12	16, 4, 15	1, 4, 16
8	4/4/0/0	246, 1, 14	49, 6, 1	24, 6, 19	8, 2, 7	0, 5, 20
12	4/4/4/0	164, 2, 4	33, 1, 18	16, 4, 13	5, 3, 21	0, 3, 21

External memory, 1 GB SD card:

Analog inputs	Channels in groups	Storage cycle (weeks, days, hours)				
		5 min	1 min	30 s	10 s	1 s
1	1/0/0/0	12825, 5, 20	2580, 4, 18	1291, 2, 5	430, 4, 14	43, 0, 12
4	4/0/0/0	8672, 5, 12	1749, 6, 13	875, 6, 13	292, 1, 8	29, 1, 14
8	4/4/0/0	4343, 1, 1	875, 1, 17	438, 0, 6	146, 0, 17	14, 4, 7
12	4/4/4/0	2896, 6, 13	583, 3, 21	292, 0, 6	97, 2, 20	9, 5, 4

 The available storage capacity of the internal and external memory can be displayed in the main menu under "**Diagnostics → Device information → Memory information**". The storage capacity depends on the specific device set-up.

Data sheet

Video recorder LINAX DR2000

Converter resolution

24 bit

Totalization

The interim, daily, monthly and yearly value and the total value can be determined (13-digit, 64 bit).

Analysis

Recording of quantity/operating time (standard function), also a min/max/median analysis within the set time frame.

Digital inputs	Input level	To IEC 61131-2: logical "0" (corresponds to -3 to +5 V), activation with logical "1" (corresponds to +12 to +30 V)
	Input frequency	max. 25 Hz
	Pulse length	Min. 20 ms (pulse counter)
	Pulse length	Min. 100 ms (control input, messages, operating time)
	Input current	max. 2 mA
	Input voltage	Max. 30 V

Selectable functions

- Functions of the digital input: control input, ON/OFF message, pulse counter (13-digit, 64 bit), operating time, message+operating time, quantity from time, Modbus slave.
- Functions of the control input: start recording, screen saver on, lock setup, time synchronization, limit monitoring on/off, lock keyboard/navigator, start/stop analysis.

Output

Auxiliary voltage output The auxiliary voltage output can be used for loop power supply or to control the digital inputs. The auxiliary voltage is short-circuit proof and galvanically isolated.

Output voltage	24 V _{DC} ±15%
Output current	Max. 250 mA

Galvanic isolation *All inputs and outputs are galvanically isolated from each other and designed for the following testing voltages:*

	Relay	Digital in	Analog in	Ethernet	RS232/RS485	USB	Auxiliary voltage output
Relay	500 V _{DC}	2 kV _{DC}	2 kV _{DC}	2 kV _{DC}	2 kV _{DC}	2 kV _{DC}	2 kV _{DC}
Digital in	2 kV _{DC}	Galvanically connected	500 V _{DC}	500 V _{DC}	500 V _{DC}	500 V _{DC}	500 V _{DC}
Analog in	2 kV _{DC}	500 V _{DC}	500 V _{DC}	500 V _{DC}	500 V _{DC}	500 V _{DC}	500 V _{DC}
Ethernet	2 kV _{DC}	500 V _{DC}	500 V _{DC}	-	500 V _{DC}	500 V _{DC}	500 V _{DC}
RS232/RS485	2 kV _{DC}	500 V _{DC}	500 V _{DC}	500 V _{DC}	-	500 V _{DC}	500 V _{DC}

Data sheet

Video recorder LINAX DR2000

	Relay	Digital in	Analog in	Ethernet	RS232/RS485	USB	Auxiliary voltage output
USB	2 kV _{DC}	500 V _{DC}	500 V _{DC}	500 V _{DC}	500 V _{DC}	Galvanically connected	500 V _{DC}
Auxiliary voltage output	2 kV _{DC}	500 V _{DC}	500 V _{DC}	500 V _{DC}	500 V _{DC}	500 V _{DC}	-

Relay outputs

A mix of low voltage (230 V) and safety extra low voltage (SELV circuits) is not permitted at the connections of the relay contacts.

Alarm relay

1 alarm relay with changeover contact.

Standard relay

5 relays with NO contact, e.g. for limit value messages (can be configured as NC contact).

Relay switching capacity

- Max. switching capacity: 3 A @ 30 V DC
- Max. switching capacity: 3 A @ 250 V AC
- Min. switching load: 300 mW

Switching cycles

>10⁵

Cable specification

Cable specification, spring terminals

All connections on the rear of the device are designed as pluggable screw or spring terminal blocks with reverse polarity protection. This makes the connection very quick and easy. The spring terminals are unlocked with a slotted screwdriver (size 0).

Please note the following when connecting:

- Wire cross-section, auxiliary voltage output, digital I/O and analog I/O: max. 1.5 mm² (14 AWG) (spring terminals)
- Wire cross-section, mains: max. 2.5 mm² (13 AWG) (screw terminals)
- Wire cross-section, relays: max. 2.5 mm² (13 AWG) (spring terminals)
- Stripping length: 10 mm (0.39 in)



No ferrules must be used when connecting flexible wires to spring terminals.

Shielding and grounding

Optimum electromagnetic compatibility (EMC) can only be guaranteed if the system components and, in particular, the lines - both sensor lines and communication lines - are shielded and the shield forms as complete a cover as possible. A shielded line must be used for sensor lines that are longer than 30 m. A shield coverage of 90% is ideal. In addition, make sure not to cross sensor lines and communication lines when routing them. Connect the shield as often as possible to the reference ground to ensure optimum EMC protection for the different communication protocols and the connected sensors.

To comply with requirements, three different types of shielding are possible:

- Shielding at both ends
- Shielding at one end on the supply side with capacitance termination at the device
- Shielding at one end on the supply side

Experience shows that the best results with regard to EMC are achieved in most cases in installations with one-sided shielding on the supply side (without capacitance termination

at the device). Appropriate internal device wiring measures must be taken to allow unrestricted operation when EMC interference is present. These measures have been taken into account for this device. Operation in the event of disturbance variables as per NAMUR NE21 is thus guaranteed.

Where applicable, national installation regulations and guidelines must be observed during the installation! Where there are large differences in potential between the individual grounding points, only one point of the shielding is connected directly with the reference ground.

i If the shielding of the cable is grounded at more than one point in systems without potential matching, mains frequency equalizing currents can occur. These can damage the signal cable or significantly impact signal transmission. In such cases the shielding of the signal cable is to be grounded on one side only, i.e. it may not be connected to the ground terminal of the housing. The shield that is not connected should be insulated!

Power supply

Terminal assignment

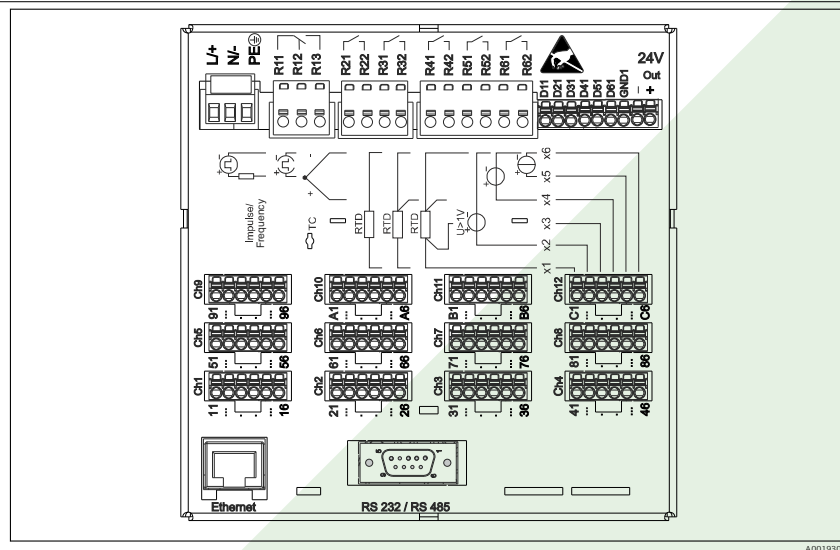

12 Terminals on back of device

Supply voltage

- Extra-low voltage power supply unit ± 24 V AC/DC (-10% / $+15\%$) 50/60Hz
- Low voltage power supply unit 100 to 230 V AC ($\pm 10\%$) 50/60Hz

i An overload protection element (rated current ≤ 10 A) is required for the power cable.

Power consumption

- 100 to 230 V: max. 35 VA
- 24 V: max. 24 VA



The power actually consumed depends on the individual operating state and the device version (LPS, USB, brightness of screen, number of channels, etc). The active power here is approx. 3 W to 20 W.

Power supply failure

Battery-backed time and data memory. The device starts automatically following a power failure.

Data sheet

Video recorder LINAX DR2000

Electrical connection	Details about the electrical connection: →  12
Connector	<ul style="list-style-type: none">■ Panel-mounted device: connected to mains via plug-in screw terminals with reverse polarity protection■ Desktop version (option): connected to mains via IEC connector
Overvoltage protection	To avoid high-energy transients on long signal cables, connect a suitable surge arrester upstream.
Connection data interface, communication	<p>USB ports (standard):</p> <p><i>1 x USB port type A (host)</i></p> <p>A USB 2.0 port is available on a shielded USB A socket at the front of the device. A USB stick, for example, can be connected to this interface as a storage medium. An external keyboard or USB hub may also be connected.</p> <p><i>1 x USB port type B (function)</i></p> <p>A USB 2.0 port is available on a shielded USB B socket at the front of the device. This can be used to connect the device for communication with a laptop, for example.</p> <p>Ethernet interface (standard):</p> <p>Ethernet interface on back, 10/100 Base-T, plug type RJ45. The Ethernet interface can be used to integrate the device via a hub or switch into a PC network (TCP/ IP Ethernet). A standard patch cable (e.g. CAT5E) can be used for the connection. Using DHCP, the device can be fully integrated into an existing network without the need for additional configuration. The device can be accessed from every PC in the network. Normally only the automatic assignment of the IP address must be configured at the client. When the device is started, it can automatically retrieve the IP address, subnet mask and gateway from a DHCP server. If a DHCP is not used, these settings must be made directly in the device (depends on the network to which the device is to be connected). Two Ethernet function LEDs are located on the rear of the device.</p> <p>The following functions are implemented:</p> <ul style="list-style-type: none">■ Data communication with PC software (analysis software, OPC server)■ Web server■ WebDAV (Web-based Distributed Authoring and Versioning) is an open standard for the provisioning of files via the HTTP protocol. The data saved on the device's SD card can be read out using a PC. A web browser or dedicated WebDAV client can be selected as network drive on the PC for this purpose. <p>Serial RS232/RS485 interface (option):</p> <p>A combined RS232/RS485 connection is available on a shielded SUB D9 socket at the rear of the device. This can be used for data transfer and to connect a modem. For communication via modem, we recommend an industrial modem with a watchdog function.</p> <ul style="list-style-type: none">■ The following baud rates are supported: 9600, 19200, 38400, 57600, 115200■ Max. cable length with a shielded cable: 2 m (6.6 ft) (RS232), or 1000 m (3281 ft) (RS485) <p> Only one interface can be used at any one time (RS232 or RS485).</p>

Performance characteristics

Response time	Input	Output	Time [ms]
	Current, voltage, pulse	Relay	≤ 550
	RTD	Relay	≤ 1150
	TC ¹⁾	Relay	≤ 1550
	Cable open circuit detection, current input	Relay	≤ 1150
	Sensor error RTD, TC	Relay	≤ 5000
	Digital input	Relay	≤ 350

1) If internal measuring point temperature compensation is used, otherwise values as for voltage

Reference operating conditions	Reference temperature	25 °C (77 °F) ±5 K
	Warm-up period	120 min.
	Humidity	20 to 60 % rel. humidity

Hysteresis Can be configured for limit values in the setup

Long-term drift As per IEC 61298-2: max. ±0.1%/year (of measuring range)

Installation

Mounting location and installation dimensions The device is designed for use in a panel in non-hazardous areas.

Data sheet

Video recorder LINAX DR2000

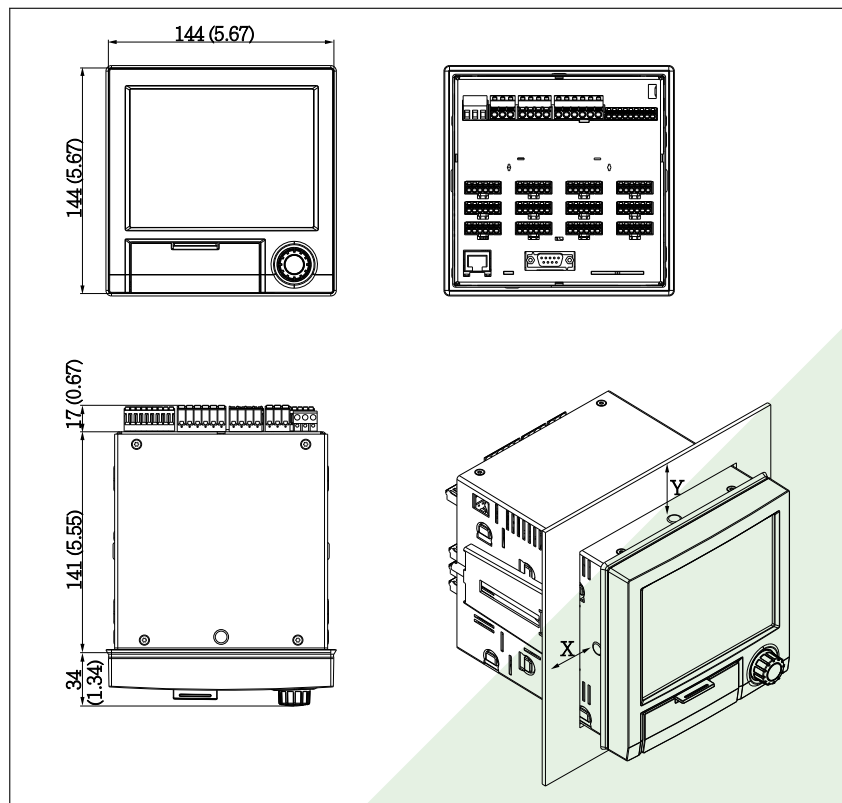

13 Panel mounting and dimensions in mm (in)

Please observe the installation depth of approx. 158 mm (6.22 in) for the device incl. terminals and fastening clips.

- Panel cutout: 138 to 139 mm (5.43 to 5.47 in) x 138 to 139 mm (5.43 to 5.47 in)
- Panel strength: 2 to 40 mm (0.08 to 1.58 in)
- Angle of vision: from the midpoint axis of the display, 75° to the left and right, 65° above and below.
- A minimum distance of 15 mm (0.59 in) mm (inch) between the devices must be observed if aligning the devices in the Y-direction (vertically above one another). A minimum distance of 10 mm (0.39 in) mm (inch) between the devices must be observed if aligning the devices in the X-direction (horizontally beside one another).
- Securing to DIN 43 834

Field housing assembly and design (optional)

As an option, the device can be ordered ready-mounted in a field housing with IP65.
Dimensions (B x H x D) approx.: 320 mm (12.6 in) x 320 mm (12.6 in) x 254 mm (10 in)

Desktop housing assembly and design (optional)

As an option, the device can be ordered ready-mounted in a desktop housing.
Dimensions (B x H x D) approx.: 293 mm (11.5 in) x 188 mm (7.4 in) x 211 mm (8.3 in)
(dimensions with bracket, feet and installed device)

Environment

Ambient temperature range	-10 to +50 °C (14 to 122 °F)	
Storage temperature	-20 to +60 °C (-4 to +140 °F)	
Humidity	5 to 85 %, not condensating	
Climate class	To IEC 60654-1: Class B2	
Electrical safety	Class I equipment, overvoltage category II Pollution level 2	
Altitude	< 2 000 m (6 561 ft) above MSL	
Degree of protection	Front	IP65 / NEMA 4 (not assessed by UL)
	Rear	IP20

Electromagnetic compatibility	EMC to all relevant requirements of the IEC/EN 61326- series and NAMUR NE21. For details see declaration of conformity. <ul style="list-style-type: none"> ■ Interference immunity: as per IEC/EN 61326 series (industrial environment) / NAMUR NE21 Maximum measured error <1% of measuring range ■ Interference emissions: as per IEC 61326-1 Class A 	
-------------------------------	--	--

Mechanical construction

Design, dimensions	Information about design and dimensions → 70	
Weight	<ul style="list-style-type: none"> ■ Panel-mounted device with maximum configuration: approx. 2.2 kg (4.85 lbs) ■ Desktop housing (excluding device): approx. 2.3 kg (5 lbs) ■ Field housing (excluding device): approx. 4 kg (8.8 lbs) 	
Materials	Front frame	Zinc die cast GD-Z410, powder-coated
	Sight glass	Transparent Makrolon plastic (FR clear 099) UL94-V2
	Flap; jog/shuttle dial	Plastic ABS UL94-V2
	Mounting guide rail for PCBs; motherboard fixing unit; display retainer plate	Plastic PA6-GF15 UL94-V2
	Seal to panel wall; seal to display; seal in flap; seal to navigator	Rubber EPDM 70 Shore A
	Casing; rear panel	Galvanized sheet steel St 12 ZE

All materials are silicone-free.

Data sheet

Video recorder LINAX DR2000

Materials of desktop housing

- Housing half-panels: sheet steel, electrolytically plated (powder-coated)
- Side sections: aluminum extruded section (powder-coated)
- Section ends: colored polyamide

Display and operating elements

Operating concept	<p>The device can be operated directly onsite, or via remote configuration with the PC via interfaces and operating tools (Web server).</p> <p>Integrated operating instructions The device's simple control system enables you to perform commissioning for many applications without the need for hard copy operating instructions. The device has an integrated help function and displays operating instructions directly on screen if the navigator (jog/shuttle dial) is pressed for longer than 3 seconds.</p>
Local operation	<p>Display elements</p> <p><i>Type</i> TFT color display</p> <p><i>Size (diagonal screen measurement)</i> 145 mm (5.7")</p> <p><i>Resolution</i> VGA 307,200 pixels (640 x 480 pixels)</p> <p><i>Backlight</i> 70,000 h half value time (= half brightness)</p> <p><i>Number of colors</i> 262,000 viewable colors, 256 colors used</p> <p><i>Viewing angle</i> Viewing angle: 130° vertical, 150° horizontal</p> <p><i>Screen display</i></p> <ul style="list-style-type: none">▪ Background color white▪ Active channels can be assigned to up to 4 groups. These groups can be given a name e.g. "Temp. boiler 1" or "Daily averages" so that they can be uniquely identified.▪ Linear scaling▪ Measured value history: quick retrieval of historical data with zoom function▪ Preformatted screen displays such as horizontal or vertical curve presentation, bar graph display or digital display.

Data sheet

Video recorder LINAX DR2000

Operating elements

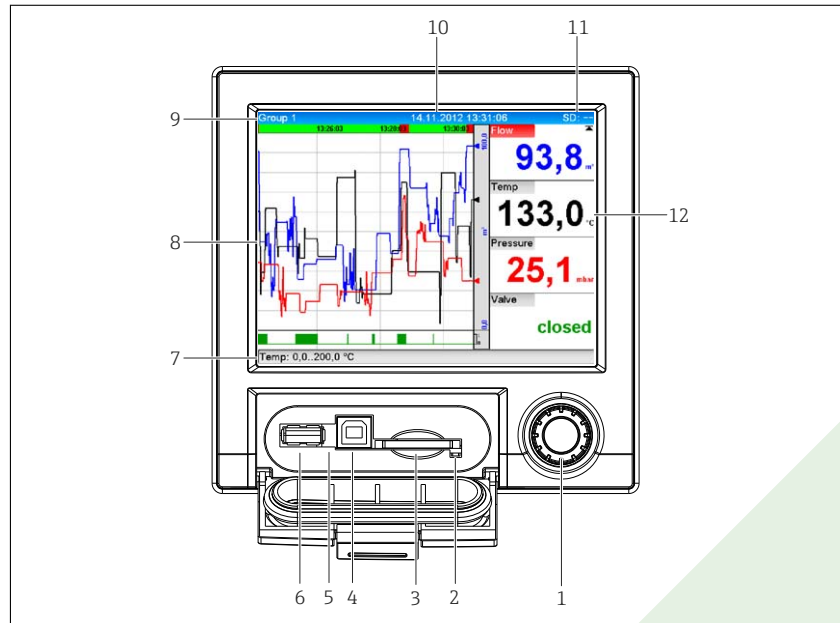

14 Front of device with open flap

Item No.	Operating function (display mode = display of measured values) (Setup mode = operating in the Setup menu)
1	"Navigator": jog/shuttle dial for operating with additional press/hold function. In display mode: turn the dial to switch between the various signal groups. Press the dial to display the main menu. In setup mode or in a selection menu: turn the dial counterclockwise to move the bar or the cursor upwards or to the left, changes the parameter. Turning clockwise moves the bar or cursor down or clockwise, changes parameter.
2	LED at SD slot. Orange LED lights up or flashes when the device writes to or reads from the SD card. Do not remove the SD card if the LED is lit or flashing! Risk of data loss!
3	Slot for SD card
4	USB B socket "Function" e.g. to connect to PC or laptop
5	Green LED lit: power supply present
6	USB A socket "Host" e.g. for USB memory stick or external keyboard
7	In display mode: alternating status display (e.g. set zoom range) of the analog or digital inputs in the appropriate color of the channel. In setup mode: different information can be displayed here depending on the display type.
8	In display mode: window for measured value display (e.g. curve display). In setup mode: display of operating menu
9	In display mode: current group name, type of evaluation In setup mode: name of the current operating item (dialog title)
10	In display mode: displays current date/time In setup mode: --

Data sheet

Video recorder LINAX DR2000

Item No.	Operating function (display mode = display of measured values) (Setup mode = operating in the Setup menu)
11	In display mode: alternating display indicating the percentage space on the SD card or USB stick that has already been used. Status symbols are also displayed in alternation with the memory information. In setup mode: the current "direct access" operating code is displayed
12	In display mode: display of current measured values and the status in the event of an error/alarm condition. In the case of counters, the type of counter is displayed as a symbol.  If a measuring point has limit value status, the corresponding channel identifier is highlighted in red (quick detection of limit value violations). During a limit value violation and device operation, the acquisition of measured values continues uninterrupted.

Languages The following languages can be selected in the operating menu: German, English, Spanish, French, Italian, Dutch, Swedish, Polish, Portuguese, Czech, Russian, Japanese, Chinese (Traditional), Chinese (Simplified)

Remote operation **Device access via operating tools**
Device configuration and measured value retrieval can also be done via interfaces. The following operating tools are available for this purpose:

Operating tool	Functions	Access via
Analysis software, SQL database support (included in the delivery)	<ul style="list-style-type: none"> ▪ Export of saved data (measured values, analyses, event log) ▪ Visualization and processing of saved data (measured values, analyses, event log) ▪ Safe archiving of exported data in a SQL database 	RS232/RS485, USB, Ethernet
Web server (integrated into the device; access via browser)	<ul style="list-style-type: none"> ▪ Display of current and historical data and measured value curves via the web browser ▪ Easy configuration without additional installed software ▪ Remote access to device and diagnostic information 	Ethernet
OPC server (optional)	The following instantaneous values can be provided: <ul style="list-style-type: none"> ▪ Analog channels ▪ Digital channels ▪ Mathematics ▪ Totalizer 	RS232/RS485, USB, Ethernet

System integration The device has (optional) fieldbus interfaces for exporting process values. Measured values and statuses can also be transmitted to the device via fieldbus. Alarms or errors in the context of data transmission are displayed depending on the bus system (e.g. status byte). The process values are transferred in the same devices that are used for display at the device.

Ethernet

The following functions are implemented:

- Data communication with PC software (analysis software, OPC server)
- Web server

Modbus RTU/TCP slave

The device can be connected to a Modbus system via RS485 or Ethernet interface. Up to analog inputs and 6 digital inputs can be transmitted via Modbus and stored in the device.

Data sheet

Video recorder LINAX DR2000

Certificates and approvals

CE mark The measuring system meets the legal requirements of the applicable EC guidelines. These are listed in the corresponding EC Declaration of Conformity together with the standards applied. Confirms successful testing of the device by affixing to it the CE mark.

Other standards and guidelines

- IEC 60529:
Degree of protection provided by housing (IP code)
- IEC/EN 61010-1:
Safety requirements for electrical equipment for measurement, control and laboratory use
- IEC/EN 61326 Series:
Electromagnetic compatibility (EMC requirements)

Ordering information

Scope of delivery The scope of delivery of the device comprises:

- Device (with terminals, as per order)
- 2 fastening clips
- USB cable
- Optional: Industrial grade SD card (card is located in the SD slot behind the flap on the front of the housing)
- Analysis software on CD-ROM
- Operating Instructions on CD-ROM



CAMILLE BAUER

Auf uns ist Verlass.

Camille Bauer Metrawatt AG
Aargauerstrasse 7
CH-5610 Wohlen / Schweiz
Phone: +41 56 618 21 11
Fax: +41 56 618 21 21
info@cbmag.com
www.camillebauer.com