

Operating instructions

SINEAX VQ604s

Programmable multifunctional transmitter with very fast setting times

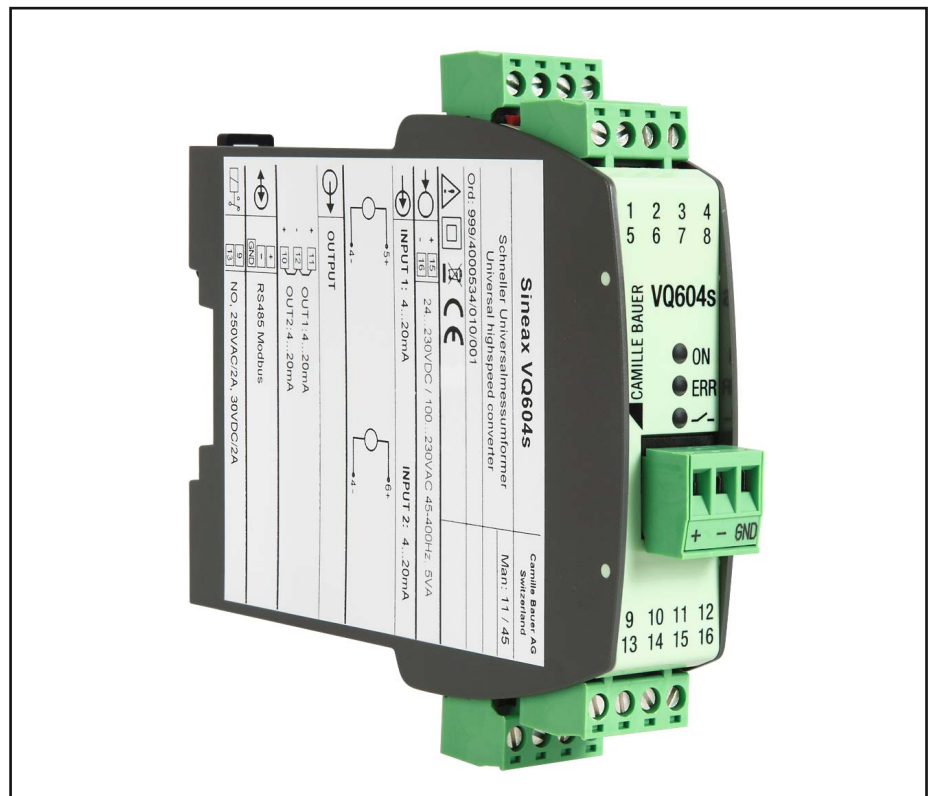

VQ604s Be

Version 01

12.12

Camille Bauer AG
Aargauerstrasse 7
CH-5610 Wohlen/Switzerland
Phone +41 56 618 21 11
Fax +41 56 618 21 21
info@camillebauer.com
www.camillebauer.com

 **CAMILLE BAUER**

Operating instructions

Programmable multifunctional transmitter SINEAX VQ604s

First read, then ...

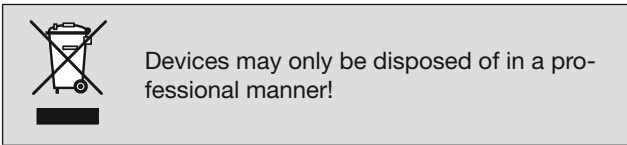
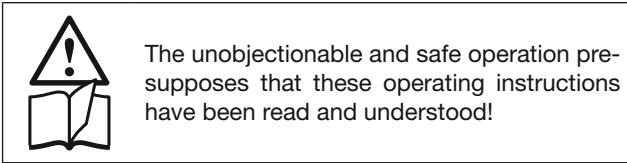

Contents

1. Functional description	2
2. Connection to a PC and communication via CB-Manager	2
3. Block diagram.....	3
4. Technical data.....	4
5. Signal flow	8
6. Modbus interface.....	9
6.1 EIA-RS-485 Standard.....	9
6.2 Coding and addressing.....	9
6.3 Mapping	10
6.4 Device identification	10
6.5 Measured values	11
6.6 Configuration parameters.....	12
7. Electric connections	18
8. Dimensional drawing	20
9. Accessories	20
10. Conformity declaration	20

1. Functional description

VQ604s is a multifunctional transmitter for top-hat rail assembly with the following main characteristics:

- Fast measurement of DC voltage, DC current, temperature (RTD, TC) and resistance
- Setting time up to 10 ms
- Sensor connection without any external jumpers
- 2 inputs (e.g. for sensor redundancy or difference formation)
- 2 outputs (I)
- 2 inputs can be linked with each other and allocated to the 2 outputs which enables calculations and sensor monitoring (e.g. prognostic maintenance of sensors)
- System capability: Communication via Modbus interface
- Freely programmable relay, e.g. for limit or alarm signalling
- AC/DC wide-range power supply unit
- Pluggable high-quality screw or spring cage terminals

All settings of the instrument can be adapted to the measuring task by PC software. The software also serves visualising, commissioning and service.

2. Connection of SINEAX VQ604s to a PC and communication via CB-Manager.

VQ604s communicates with a PC (CB-Manager) via an RS 232/RS485 interface and a MODBUS protocol.

Select the following settings in this respect:

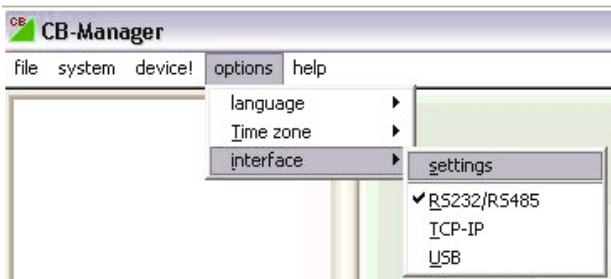

Select the RS 232/ RS485 interface under Options / Interface.

This is also applicable if an RS485/USB converter is used and the converter is connected to the computer via the USB connection.

Subsequently, enter the following settings under Options / Interface / Settings:

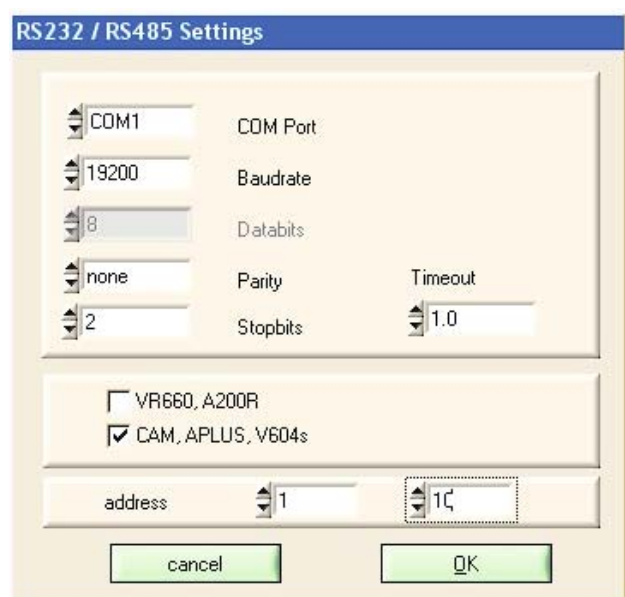

The existing COM ports are determined as the communication interface when starting the program and selecting RS232/RS485. Only COM ports found are available for selection.

Limiting the range of possible device addresses speeds up the search of connected devices considerably.
 Example: If only 2 devices are connected, it makes sense to select the address range from 1 to 2.

All settings are stored as the program is terminated. If the COM port is not available upon the next start of the program (e.g. because the converter has not been plugged in) another valid interface is set.

To determine which COM port has been allocated to the RS485 converter (if required), please proceed as follows:

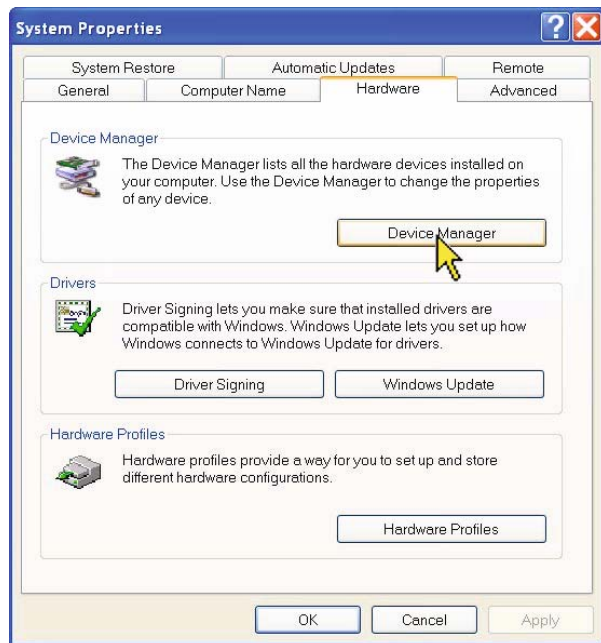

The COM port of an external RS232 or RS485 converter may be determined (and, if required, changed) via the Windows system control.

Example for Windows XP: **System control => System**



This example shows the COM ports of a PCMCIA card and a USB-RS232 converter:

- Silicom Serial Card: COM1
- USB-RS232 adapter: COM4

If you use the Camille Bauer USB-RS485 converter (Article Number 163189), the same is to be connected as follows:

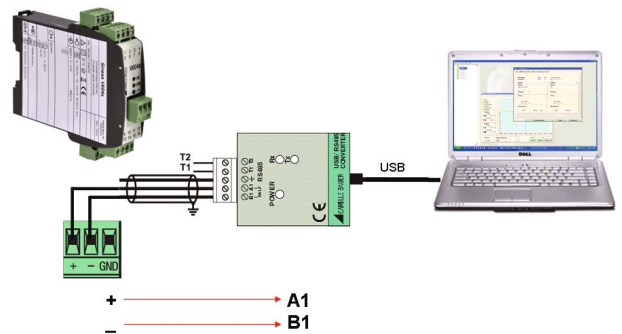

3. Block diagram

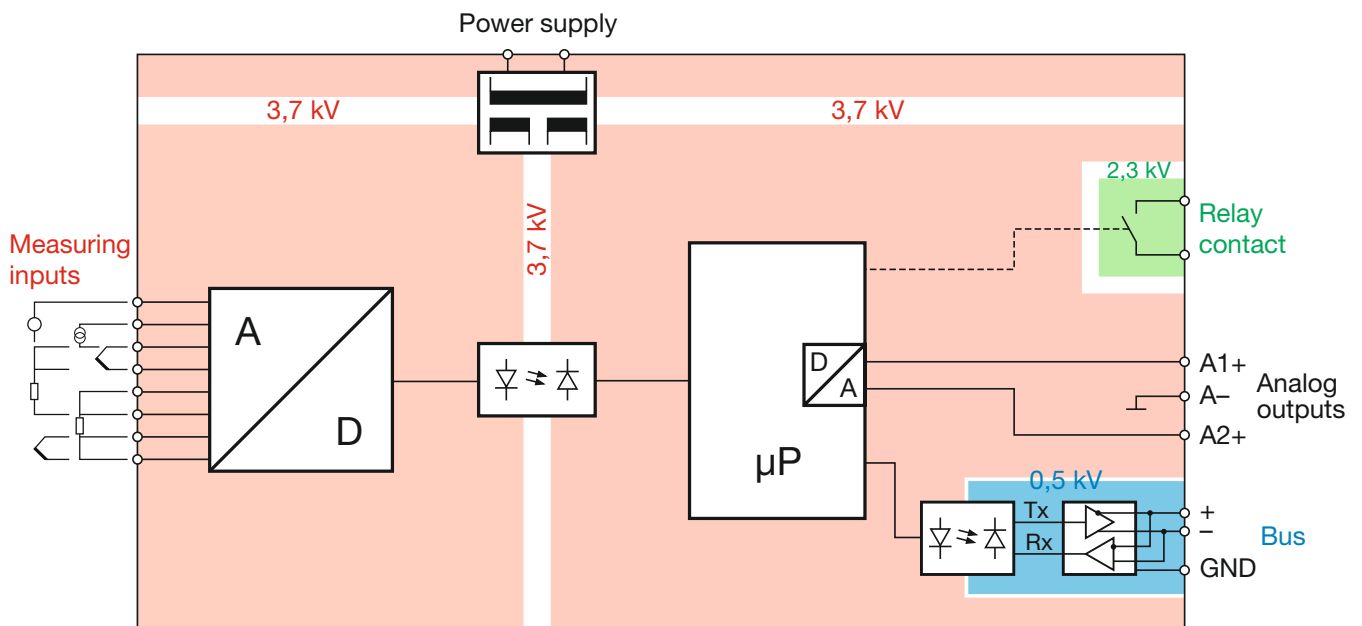

4. Technical data

Table 1: Input variables, measuring ranges

Measurement type	Measuring range	Minimum span
DC voltage [mV]	-1000 ... 1000 mV	2 mV
DC current [mA]	-50 ... 50 mA	0,2 mA
Resistance [Ω]	0 ... 5000 Ω	8 Ω
RTD Pt100	-200 ... 850 °C	20 K
RTD Ni100	-60 ... 250 °C	15 K
TC Type B	0 ... 1820 °C	635 K
TC Type E	-270 ... 1000 °C	34 K
TC Type J	-210 ... 1200 °C	39 K
TC Type K	-270 ... 1372 °C	50 K
TC Type L	-200 ... 900 °C	38 K
TC Type N	-270 ... 1300 °C	74 K
TC Type R	-50 ... 1768 °C	259 K
TC Type S	-50 ... 1768 °C	265 K
TC Type T	-270 ... 400 °C	50 K
TC Type U	-200 ... 600 °C	49 K
TC TypeW5Re-26Re	0 ... 2315 °C	135 K
TC TypeW3Re-25Re	0 ... 2315 °C	161 K

Measuring input 1

Direct voltage

Measuring range mV For limits see Table 1
 $R_i > 10 \text{ M}\Omega$, continuous,
 overload max. $\pm 1200 \text{ mV}$

Direct current

Measuring range mA For limits see Table 1
 $R_i = 11 \Omega$, continuous,
 overload max. $\pm 50 \text{ mA}$

Resistance thermometer RTD

Resistance measurement types Pt100 (IEC 60751), adjustable Pt20...Pt1000
 Ni100 (DIN 43760), adjustable Ni50...Ni1000
 Measuring range limits See Table 1
 Wiring 2, 3 or 4-wire connection
 Measuring current 0.2 mA
 Line resistance 30 Ω per line, in 2-wire connection adjustable or calibratable

Thermocouples TC

Thermocouples Type B, E, J, K, N, R, S, T (IEC 60584-1)
 Type L, U (DIN 43760)
 Type W5Re-W26Re, W3Re-W25Re (ASTM E988-90)
 Measuring range limits See Table 1
 Cold junction compensation Internal (with installed Pt100), with Pt100 on terminals or external with reference junction
 $-20 \dots 70 \text{ }^\circ\text{C}$

Resistance measurement, teletransmitter, potentiometer

Measuring range limits See Table 1
 Wiring 2, 3 or 4-wire connection
 Resistance teletransm. Type WF and WF DIN
 Measuring current 0.2 mA
 Line resistance 30 Ω per line, in 2-wire connection adjustable or calibratable

Measuring input 2

Direct current

Measuring range mA Same as Measuring input 1

Direct voltage

Measuring range mV Same as Measuring input 1

Resistance thermometer RTD

Same as Measuring input 1 except:
 Wiring 2 or 3-wire connection

Thermocouples TC

Same as Measuring input 1

Resistance measurement, teletransmitter, potentiometer

Same as Measuring input 1 except:
 Wiring 2 or 3-wire connection



Please note:

Measuring inputs 1 and 2 are galvanically connected. If 2 input sensors or input variables are used, observe combination options in Table 3 (page 19) and circuit instructions (page 18)!

Analog outputs 1 and 2

The two outputs are galvanically connected and have a common earth. Voltage and current output software-configurable.

Direct current

Output range $\pm 20 \text{ mA}$, range may be freely set
 Burden voltage max. 12 V
 Open circuit voltage < 20 V
 Limit Adjustable, max. $\pm 22 \text{ mA}$
 Residual ripple < 0.2 mA pp (after low pass 10 kHz)

Output settings

Limit
 Gain/offset trimming
 Inversion

Relay contact output

Contact 1 pole, normally open contact (NO)
 Switching capacity AC: 2 A / 250 V
 DC: 2 A / 30 V

Bus/programming connection

Interface, protocol RS-485, Modbus RTU
 Baudrate 9,6...115,2 kBaud, adjustable

Transmission behaviour

Measured variables for the outputs

- Input 1
- Input 2
- Input 1 + Input 2
- Input 1 – Input 2
- Input 2 – Input 1
- Input 1 · Input 2
- Minimum value, maximum value or mean value of Input 1 and Input 2
- Sensor redundancy Input 1 or Input 2

Transmission functions Linear, Absolute amount, scaling (gain/ offset), magnifier function (zoom) user-specific via basic value table (24 basic values per measured variable)

Settling time: Adjustable 0.01...30 s, depending on the device configuration

Line frequency suppression

Line hum which is superimposed on the signal can be attenuated by a filter. The device performs a line frequency suppression. For this purpose, the line frequency must be entered.

The suppression works on the frequency (fsys) and its multiples (i.e. 1x, 2x, 3x, ...Nx-fsys).

The set frequency is simultaneously the scanning frequency of the internal A/D converter and thus also has an influence on the setting time. (See specified time/setting time).

Specified time/setting time

The setting time (t99%) is provided for the respective parameter and is applicable to both inputs. The longer this time is, the better the filtration of measuring fluctuations can be effected.

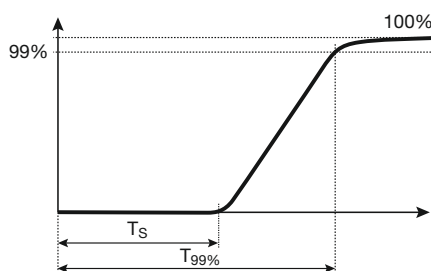

The minimum setting time depends on the following settings:

- Number of active inputs
- Type of measurement
- Selected (line) frequency (line hum suppression)
- Sensor error monitoring (breakage, short circuit)

The following table shows the minimum setting times with an active measuring input und a frequency of e.g. 50Hz or 1000Hz set at the device:

Type of measurement	Error monitoring	Minimum setting time [ms]	
		Frequency 50 Hz	Frequency 1000 Hz
Voltage [mV]		48	10
Current [mA]		48	10
Thermocouple internally compensated	Breakage	249	97
Resistance [Ω] 2L	Breakage Short circuit	137	23
Resistance [Ω] 3L, WF, WF-DIN	Breakage Short circuit	338	110
Resistance [Ω] 4L	Breakage Short circuit	296	106

Using the CB-Manager configuration software (part of the scope of delivery) the minimum setting time can be calculated with any possible configuration and frequency.

Limit values and monitoring

Number of limit values 2

Measured variables for limit values

- Input 1
- Input 2
- Measured variable for outputs
- Input 1 – Input 2 (e.g. drift monitoring in case of 2 sensors)
- Input 2 – Input 1 (e.g. drift monitoring in case of 2 sensors)

Functions Absolute amount
Gradient dx/dt (e.g. temperature gradient monitoring)

Time delay Adjustable 0...3600 s

Signaling Relay contact, alarm LED, Status 1

Sensor breakage and short circuit monitoring measuring input

Signalling Relay contact, alarm LED, Status 1

Output value in case of a fault

Signalling to alarm LED In case of a sensor error, the defective input (1 or 2) is signalled by the number of flashes of the alarm LED (1x or 2x).

In case of a failure at both inputs: Alarm LED does not flash.

Other monitoring operations

Drift monitoring Monitoring of measured value between 2 input sensors for a certain period of time (e.g. due to different sensor response times). If this time is exceeded, an alarm is signalled. (See Limit values 1 and 2)

Sensor redundancy Measurement with 2 temperature sensors; if Sensor 1 fails (fault) Sensor 2 is activated for bridging (see measuring variable for outputs).

TC W5Re-W26Re,
W3Re-W25Re
DC voltage mV $\pm 0.2\% \pm 0.015 \text{ mV}$
DC current mA $\pm 0.2\% \pm 0.0015 \text{ mA}$

measurement value $> 300^\circ\text{C}$

Alarm signalling

Relay contact With closed contact, the yellow LED shines, invertible alarmfunction

Alarm LED

Time delay Adjustable 0...60 s

Output value in case of a fault For sensor breakage and short circuit, value adjustable $-10\% \dots 110\%$

Additional error (additive)

High range minimum value (Minimum value $> 40\%$ of maximum value): $\pm 0.2\%$ of maximum value

Small output range $\pm 0.2\% * (\text{reference range} / \text{new range})$

Cold junction compensation internal typical ± 3 to 5 K

Magnifier function $\pm \text{Zoom factor} \times (\text{basic accuracy} + \text{additional error})$

Zoom factor = measured variable range / zoom range

Power supply

Rated voltage UN	Tolerance
24...230 V DC *	$\pm 15\%$
100...230 V AC, 45...400 Hz	$\pm 15\%$

* In case of a power supply voltage $> 125 \text{ V DC}$, the power supply circuit must contain an external fuse.

Power consumption $< 3 \text{ W}$ or 7 VA

Mains frequency $> 50 \text{ Hz}$ in resistance measurement and RTD: $\pm 0.05 \%$

Influencing factors

Ambient temperature $\pm 0.2\%$ per 10 K at reference conditions
other settings: basic accuracy and additional errors per 10 K

Long-term drift $\pm 0.1\%$

Common mode/series mode influence $\pm 0.2\%$

Displays at the instrument

LED	Color	Function
ON	green	Power on
	green flashing	Communication activ
ERR	red	Alarm
	yellow	Relay on

Ambient conditions

Operating temperature $-25 \dots +55^\circ\text{C}$

Storage temperature $-40 \dots +70^\circ\text{C}$

Relative humidity $\leq 75\%$, no condensation

Range of utilisation Internal room up to 2000m above sea level

Configuration, programming

Operation with PC software «CB-Manager»

Installation details

Design Top-hat rail housing U4
Combustibility class V-0 according to UL 94

Dimensions See dimensional drawing

Assembly For snap-on fastening on top-hat rail (35 x 15 mm or 35 x 7.5 mm) according to EN 50 022

Terminals Pluggable, 2.5 mm²
Front plug spring terminal 1.5 mm²

Weight 0.14 kg

Accuracies (according to EN/IEC 60770-1)

Reference conditions

Ambient temperature $23^\circ\text{C} \pm 2 \text{ K}$

Power supply 24 V DC

Reference value Span

Settings Input 1: Direct voltage mV, 0...1000 mV
Output 1: 4...20 mA, burden resistance 300 Ω
Mains frequency 50 Hz,
Setting time 50 ms
Input 2, output 2, relay, monitoring off or not active

Installation position: Vertically, detached

Basic accuracy

At reference conditions $\pm 0.2\%$

Other types of measurement and input ranges:

RTD Pt100, Ni100 $\pm 0.2\% \pm 0.3 \text{ K}$

Resistance measurement $\pm 0.2\% \pm 0.1 \Omega$

TC Type K, E, J, T, N, L, U $\pm 0.2\% \pm 0.4 \text{ K}$,
measurement value $> -100^\circ\text{C}$

TC Type R, S $\pm 0.2\% \pm 2.4 \text{ K}$

TC Type B $\pm 0.2\% \pm 2.4 \text{ K}$,

Product safety, regulations

Electromagnetic compatibility	EN 61 000-6-2 / 61 000-6-4
Ingress protection (acc. IEC 529 or EN 60529)	Housing IP 40 terminal IP20
Electric design	Acc. IEC or EN 61 010
Degree of pollution	2
Between power supply and all circuits and between the measuring input (1 + 2) and all circuits	Reinforced insulation overvoltage category III Working voltage 300 V Test voltage 3.7 kV AC rms
Between output (1 + 2) and relay contact	Reinforced insulation overvoltage category II Working voltage 300 V Test voltage 2.3 kV AC rms
Between output (1 + 2) and the bus connection	Functional insulation Working voltage <50 V Test voltage 0.5 kV AC rms
Environmental tests	EN 60 068-2-1/-2/-3 EN 60 068-2-27 Shock: 50g, 11ms, sawtooth, half-sine EN 60 068-2-6 Vibration: 0.15mm/2g, 10...150Hz, 10 cycles

Explanation of symbols on the type label

Symbol	Meaning
	Double insulation, device of protection class 2
	CE conformity mark. The device fulfills the requirements of the applicable EG directives
	Caution! General hazard point. Read the operating instructions.
	The instruments must be only be disposed of in the correct way!
	General symbol: Input
	General symbol: Output
	General symbol: Power supply
	General symbol: Communication
	General symbol: Relay

Type label

Sineax VQ604s		Camille Bauer AG Switzerland
Schneller Universalmessumformer Universal highspeed converter		Man: 12 / 7 NLB: XXXX
Ord: 999/123456/999/001		
	+ 15 - 16	24...230VDC / 100...230VAC 45-400Hz, 5VA
	INPUT 1: 4...20mA	INPUT 2: 4...20mA
	OUTPUT	
+ 11 - 12 + 10	} OUT1: 4...20mA } OUT2: 4...20mA	
	+ - GND 	RS485 Modbus
	9 13 	NO, 250VAC/2A, 30VDC/2A

5.5 Signal flow

The following diagram shows the VQ604s signal flow. All relevant measured variables and parameters determining the signal flow are represented.

Overview signal flow

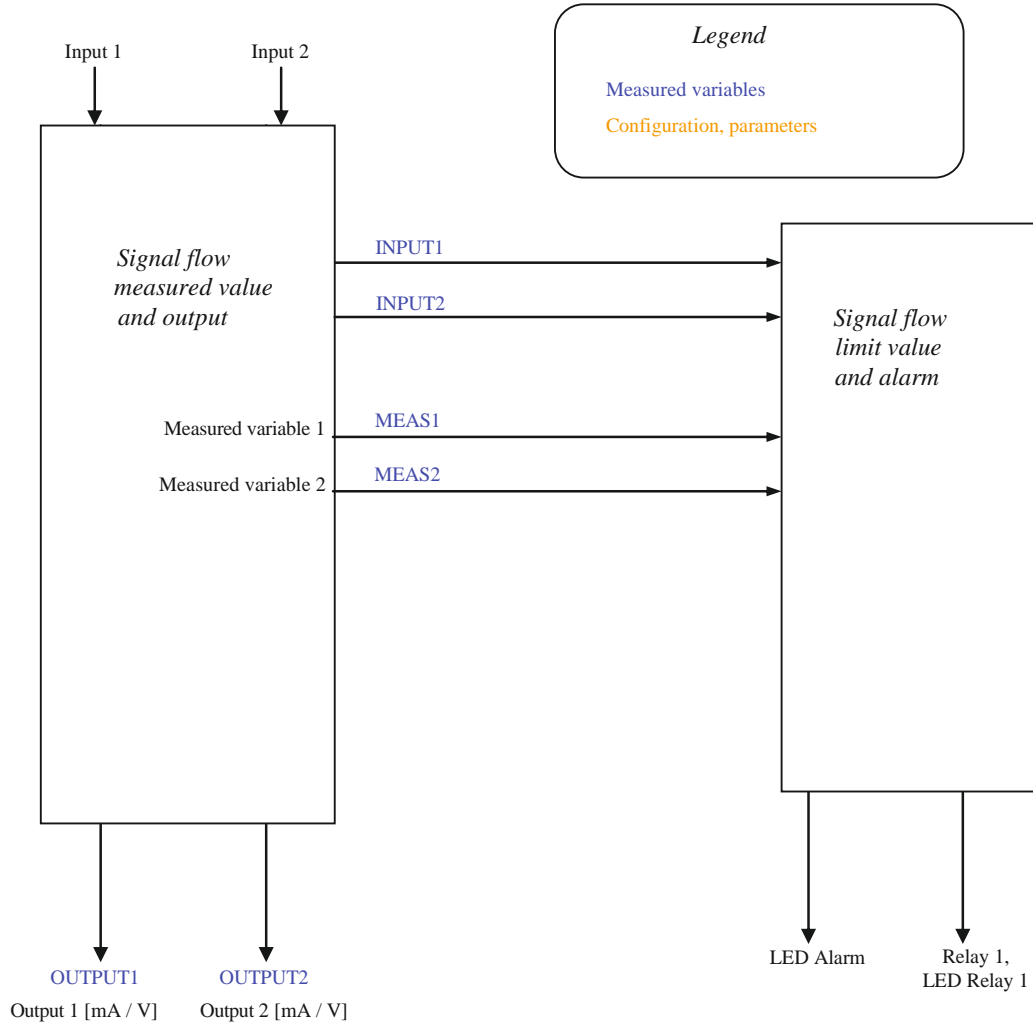

Signal flow measured value and output

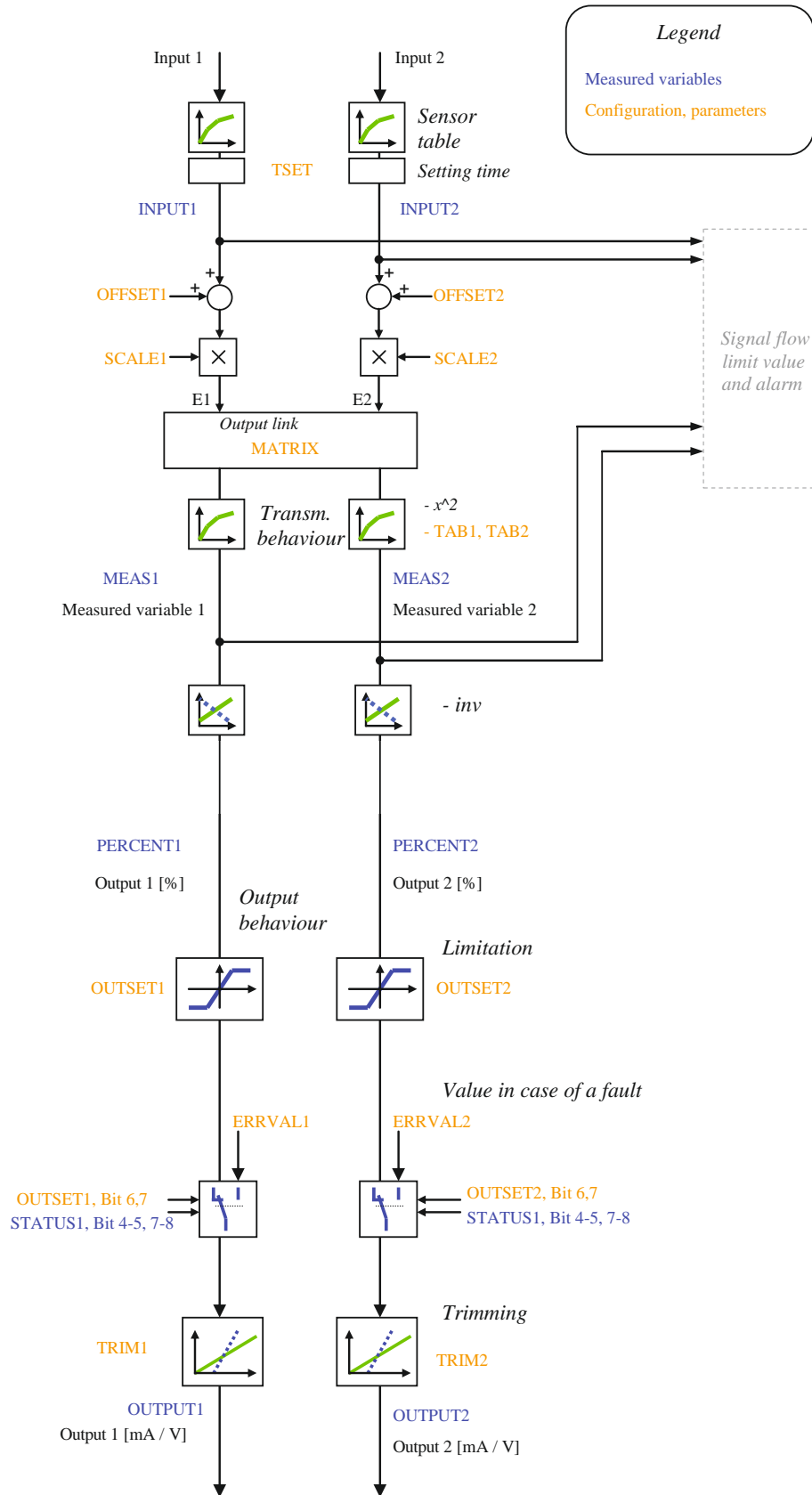

Signal flow limit value and alarm

Legend

Measured variables

Configuration, parameters

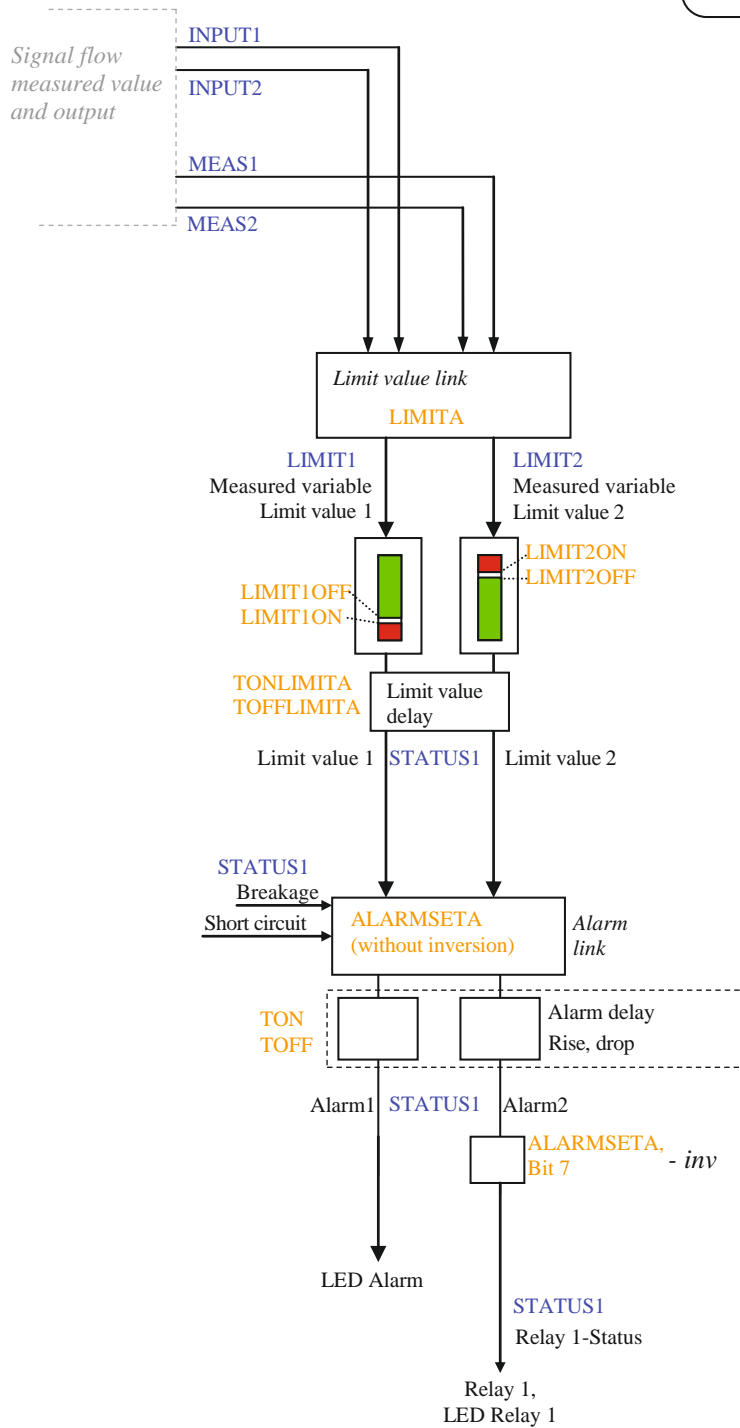

6. Modbus interface

6.1 EIA-RS-485 Standard

The EIA-RS-485 standard defines the physical layer of the Modbus interface.

Coding

The data is transmitted in serial form via the 2-wire bus. The information is coded as a difference signal in the NRZ code. Positive polarity signals a logic 1, negative polarity signals the logic 0.

Connections

A shielded, twisted, 2-conductor cable should be used as a bus cable. Shielding serves improved electromagnetic compatibility (EMC). Depending on the source of information, the description of Conductor A and B is contradictory.

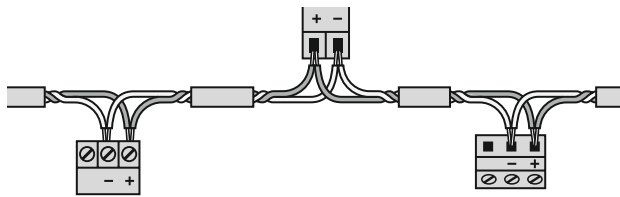

The potential difference of all bus participants may not exceed $\pm 7V$. Therefore, the use of a shield or a third conductor (ref line) is recommended to create potential equalisation.

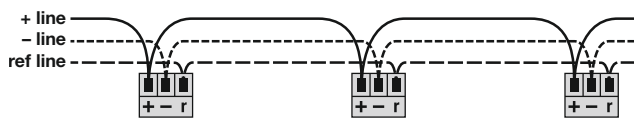

Topology

Both ends of the bus cable must be equipped with a line terminator. Supplementing the line termination resistance R_T of the EIA-RS-485 standard an additional resistance R_U (pull-up) must be wired against the supply voltage and a resistance R_D (pulldown) against the reference potential. These two resistances ensure a defined idle potential on the line when none of the participants is sending.

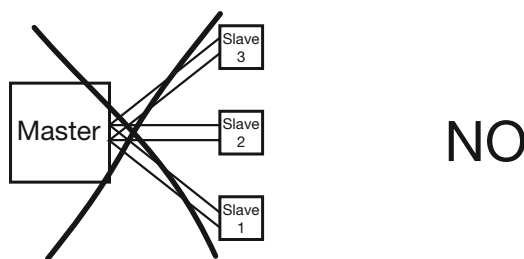
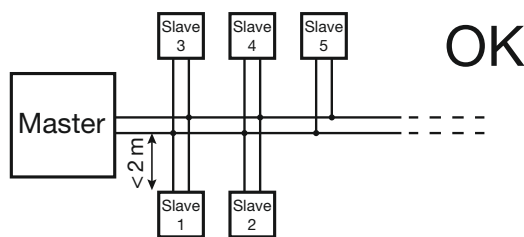
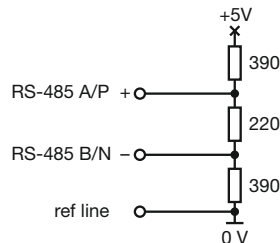

System requirements

Cable:	Twisted, 2-wire line, wave resistance 100 to 130 Ω , min. 0.22mm ² (24AWG)
Line length:	Maximum 1'200m depending on the transmission rate
Participants:	Maximum 32 per segment
Rate:	9'600, 14'400, 19'200, 38'400, 56'000, 57'600, 115'200 Baud
Mode:	11 bit format - 2 stop bit without parity or 1 stop bit with even/uneven parity

6.2 Coding and addressing

Addressing

In the telegram, all data addresses refer to zero. The first data element is always addressed via the 0 address. For example, the coil which is known as "Coil 1" in the device, is addressed as "Coil 0" in the telegram. Coil 127 is addressed as 0x007E.

Holding register 40001 is addressed as Register 0 in the telegram. The function code of the telegram already states that a "holding register" is concerned. Consequently, the reference to "4XXXX" is implicit.

Holding register 40108 is addressed as 0x006B (107 decimal).

Serialisation

The specification defines the telegrams as byte sequences. The respective physical layer (RS485, Ethernet) is responsible for the correct serialisation of the bytes (MSB or LSB First). RS485 (UART, COM) transmits the "Least Significant Bit" first (LSB First) and adds the synchronisation and backup bits (start bit, parity bit and stop bit).

Start	1	2	3	4	5	6	7	8	Par	Stop
-------	---	---	---	---	---	---	---	---	-----	------

Bits

Bits are represented within a byte in a conventional manner with the MSB (Bit 7) leftmost and the LSB (Bit 0) rightmost (0101'1010 = 0x5A = 90). An example for the inquiry of Coils 20 to 40 of Slaves 17.

Byte	Inquiry		Response	
	0	Slave address	0x11	Slave address
1	Function code	0x01	Function code	0x01
2	Start address	0x00	Byte count	0x03
3	19 = Coil 20	0x13	Byte 0	0xCD
4	Number	0x00	Byte 1	0x6B
5	20...40 = 21	0x15	Byte 2	0x01

The start address in the inquiry plus the bit position in response byte 0 corresponds to the coil address. Commenced bytes are completed with zeros. Coil 27...20 = 0xCD = 11001101b → Coil20 = ON, Coil21 = OFF, Coil22 = ON, etc.

Bytes

Modbus does not know a byte or character data type (see address space). Strings or byte arrays are mapped in "holding registers" (2 characters per register) and transmitted as a "character stream", e.g. "Hello_World".

Register	HEX	char	Register	HEX	char
40101	0x4865	,H', ,e'	40104	0x576F	,W', ,o'
40102	0x6C6C	,l', ,l'	40105	0x726C	,r', ,l'
40103	0x6F5F	,o', ,_'	40106	0x6400	,d',

Words

Registers or words are transmitted according to specification in "Big Endian" format, e.g. Read Holding Register 40101 of Slave 17.

Real

Modbus does not know any data types to represent floating point numbers. On principle, any data structures may be mapped on the 16Bit register ("cast"). The IEEE 754 standard is the most used standard to represent floating point numbers.

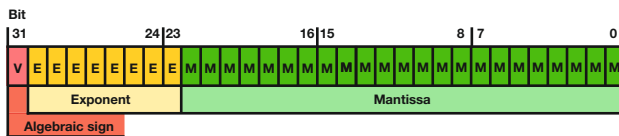

The first register contains Bits 15 – 0 of the 32-bit number (bit 0...15 of the mantissa).

The second register contains Bits 16 – 32 of the 32-bit number (algebraic sign, exponent and Bit 16- 22 of the mantissa).

6.3 Mapping

Address space

The address space may be divided into 4 address spaces according to the 4 types of data.

Space	r/w	Address area	Function code
Coil	Readable Writeable	00001 - 09999	0x01 Read Coil Status ¹⁾ 0x05 Force Single Coil ¹⁾ 0x0F Force Multiple Coils ¹⁾
Discrete input	Only readable	10001 - 19999	0x02 Read Input Status ¹⁾
Input register	Only readable	30001 - 39999	0x04 Read Input Register ¹⁾
Holding register	Readable Writeable	40001 - 49999	0x03 Read Holding Registers 0x06 Force Single Register ¹⁾ 0x10 Preset Multiple Registers

¹⁾ not implemented

To reduce the commands, the device image was represented as far as possible in "holding registers".

Segments

Address	Description	Permitted function codes
40209 - 40210	Actions	0x03 Read Holding Registers 0x10 Preset Multiple Registers
40257 - 40284	Measured values, status	
40400 - 40402	Reserved	
40515 - 40516	Settings (Modbus)	
40517 - 40761	Configuration data	
41076	Device type	0x03 Read Holding Registers

Syntax

Address	Description
Address	Start address of the described data block (register, coil or input status)
Description	Unique variable or structure description
Data type	Data type of variable (U: unsigned, INT: integer, 8/16/32 bit, REAL or CHAR[.])
#	Offset from the start address in the data type unit, for Byte 0: Low, 1: High byte
Default	Value upon delivery or after a hardware reset
Description	Exact details concerning the variable described

6.4 Device identification

The device is identified by "Read Slave ID".

Function 11h: Report Slave ID

Master telegram:

Device address	Function	CRC	
ADDR	0x11	LO	HI

Slave telegram:

Device Address	Function	Number data bytes	Slave ID	Sub ID	Data 2	CRC	
ADDR	0x11	3				LO	HI

Device ID	Sub-ID	Device	Description
0x01	0x00	VR660	Temperature controller
0x02	0x00	A200R	Display
0x03	0x01	CAM	Universal measuring unit for heavy current variables
0x04	0x00	APLUS	Multifunctional display
0x05	0x00	V604s	Universal transmitter
0x05	0x01	VB604s	Universal transmitter multi in/out
0x05	0x02	VC604s	Universal transmitter second relay
0x05	0x03	VQ604s	Universal transmitter fast setting times

Device information

Adress	Description	Data type	Description														
41076	DEVICE	UINT16	Device type														
			<table border="1"> <thead> <tr> <th>Bit</th> <th>Description</th> </tr> </thead> <tbody> <tr> <td>0</td> <td>Reserved</td> </tr> <tr> <td>1</td> <td>Reserved</td> </tr> <tr> <td>2</td> <td>0: V / mA inputs 1: 2 x mA inputs</td> </tr> <tr> <td>3</td> <td>Output 1: 0: Current output</td> </tr> <tr> <td>4</td> <td>Output 2: 0: Current output</td> </tr> <tr> <td>5-15</td> <td>Reserved</td> </tr> </tbody> </table>	Bit	Description	0	Reserved	1	Reserved	2	0: V / mA inputs 1: 2 x mA inputs	3	Output 1: 0: Current output	4	Output 2: 0: Current output	5-15	Reserved
Bit	Description																
0	Reserved																
1	Reserved																
2	0: V / mA inputs 1: 2 x mA inputs																
3	Output 1: 0: Current output																
4	Output 2: 0: Current output																
5-15	Reserved																

6.5 Measured values

Triggering action

Address	Description	Data type	#	Default	Description
40209	ACTION	UINT16		0	This register starts actions. <i>Action Description</i> 18 Input 1: With short-circuited input terminals, the line calibration is realised and the measured parameters are stored in the device. This procedure is indicated by a flashing green LED. 19 Line calibration at Input 2 (same as Input 1)
40210	ACTDAT				Additional information for the implementation of an action.

Simulation of output variables

- Writing into the PERCENT1, PERCENT2, OUTPUT1, OUTPUT2 registers interrupts the signal flow to the respective variable and the desired value is specified (However, percent and output value cannot be simulated simultaneously). The status of the simulation mode can be read in the STATUS2 status register.
- The simulation mode is terminated by writing 0 into the respective bits in the STATUS2 register.

Current measured variables

Address	Description	Data type	#	Default	Description
40257	STATUS1	UINT16		0	Status 1 <i>Bit Description</i> 0 Reserved 1 Reserved 2 Device fault 3 Parameter fault 4 Sensor breakage Input 1 5 Sensor short circuit Input 1 6 Reserved 7 Sensor breakage Input 2 8 Sensor short circuit Input 2 9 Reserved 10 Alarm 1 11 Alarm 2 (relay 1 status before inverting) 12 Limit value 1 13 Limit value 2 14 Relay 1 status 15 Device reset or new parameter values
40258	STATUS2	UINT16		0	Status of the simulation mode: A set bit indicates the simulation mode of the respective register. <i>Bit Description</i> 0 Output 1 (PERCENT1) 1 Output 1 (OUTPUT1) 2 Output 2 (PERCENT2) 3 Output 2 (OUTPUT2) The simulation mode is terminated by writing zeros into the respective bit positions (0..3).
40259	INPUT1	REAL		0.0	Measured value Input 1
40261	INPUT2	REAL		0.0	Measured value Input 2
40263	MEAS1	REAL		0.0	Measured variable for Output 1
40265	MEAS2	REAL		0.0	Measured variable for Output 2
40267	LIMIT1	REAL		0.0	Measured variable for Limit value 1
40269	LIMIT2	REAL		0.0	Measured variable for Limit value 2
40271	T_JUNCTION1	REAL		0.0	Cold junction temperature Input 1
40273	T_JUNCTION2	REAL		0.0	Cold junction temperature Input 2
40275	ELAPSED	UINT32		0	Operation hour counter [s]
40277	PERCENT1	REAL		0.0	Output 1: Scaled output variable in %
40279	PERCENT2	REAL		0.0	Output 2: Scaled output variable in %
40281	OUTPUT1	REAL		0.0	Output 1 [mA] / [V]
40283	OUTPUT2	REAL		0.0	Output 2 [mA] / [V]

6.6 Configuration parameters

Settings

Address	Description	Data type	#	Default	Description
40515	DEVADDR	UINT16		01h	MODBUS Slave address (1...247)
40516	MODBUS	UINT16		3222h	MODBUS settings
					<i>Bit Description</i>
					0-2 Baudrate
					0: 9600
					1: 14400
					2: 19200
					3: 38400
					4: 56000
					5: 57600
					6: 115200
					7: Reserved
					3 0: Odd parity
					1: Even parity
					4 0: Parity disabled
					1: Parity enabled
					5 0: 1 Stop bit
					1: 2 Stop bits
					8-15 Response delay [ms] (5..255)

Resetting of communication settings

Once the MODBUS settings have been stored in the device, communication with the device is only possible if the settings are known.

The following technique resets the MODBUS settings to the delivery status:

- Device address: 01h
- Baudrate: 19200
- Parity: None
- Stop bits: 2

A plug prepared for this purpose (Terminal + is connected to Terminal GND with a resistance of 1 kOhm) is connected to the RS485 interface before the device is switched on.

After the device has been switched on, the red LED shines for approx. 30 seconds. During this time, the green LED flashes. Subsequently, the red LED turns off (the green LED continues flashing). Within further 30 seconds, this plug has to be removed from the device.

After the successful completion of this procedure, the communication default settings are stored again in the device.

If the procedure described is not adhered to, the interface parameters are not changed.

Configuration

Address	Description	Data type	#	Default	Description																																																																																																						
40517	DATE	UINT32		0	Configuration date (UTC time stamp in seconds starting 1.1.1970)																																																																																																						
40519	TAG	CHAR[8]		“V604s“\0 or “VB604s“\0	Device text																																																																																																						
40523	INPUT1	UINT8	0	00h at 2xmA: 40h	<p>Type of measurement Input 1 FFh: Measurement is inactive</p> <p>Wiring variant A</p> <table border="0"> <tr> <td>00h:</td> <td>Voltage measurement [mV]</td> <td>Terminal</td> </tr> <tr> <td>04h:</td> <td>Thermocouple internally compensated [K]</td> <td>3,4</td> </tr> <tr> <td>60h:</td> <td>Thermocouple with ext. cold junction thermostat [K]</td> <td>3,4</td> </tr> <tr> <td>21h:</td> <td>Resistance thermometer 2-wire [K]</td> <td>1,4</td> </tr> <tr> <td>22h:</td> <td>Resistance thermometer 3-wire [K]</td> <td>1,3,4</td> </tr> <tr> <td>23h:</td> <td>Resistance thermometer 4-wire [K]</td> <td>1,2,3,4</td> </tr> <tr> <td>24h:</td> <td>Thermocouple with ext. Pt100 on Terminals 1-4 [K]</td> <td>1,3,4</td> </tr> <tr> <td>44h:</td> <td>Thermocouple with ext. Pt100 on Terminals 2-8 [K]</td> <td>3,4,2,8</td> </tr> <tr> <td>01h:</td> <td>Resistance measurement 2-wire [Ω]</td> <td>1,4</td> </tr> <tr> <td>02h:</td> <td>Resistance measurement 3-wire [Ω]</td> <td>1,3,4</td> </tr> <tr> <td>03h:</td> <td>Resistance measurement 4-wire [Ω]</td> <td>1,2,3,4</td> </tr> <tr> <td>42h:</td> <td>Resistance teletransmitter WF [Ω]</td> <td>1,3,4</td> </tr> <tr> <td>62h:</td> <td>Resistance teletransmitter WFDIN [Ω]</td> <td>1,3,4</td> </tr> <tr> <td>20h:</td> <td>Voltage measurement [V]</td> <td>6,4</td> </tr> <tr> <td>40h:</td> <td>Current measurement [mA]</td> <td>5,4</td> </tr> <tr> <td>06h:</td> <td>Sensor earthed: Voltage measurement [mV]</td> <td>3,4</td> </tr> <tr> <td>07h:</td> <td>Sensor earthed: TC internally compensated [K]</td> <td>3,4</td> </tr> <tr> <td>66h:</td> <td>Sensor earthed: TC, ext. cold junction thermostat [K]</td> <td>3,4</td> </tr> <tr> <td>27h:</td> <td>Sensor earthed: TC with ext. Pt100 on Terminals 1-4 [K]</td> <td>1,3,4</td> </tr> </table> <p>Wiring variant B</p> <table border="0"> <tr> <td>10h:</td> <td>Voltage measurement [mV]</td> <td>7,8</td> </tr> <tr> <td>14h:</td> <td>Thermocouple internally compensated [K]</td> <td>7,8</td> </tr> <tr> <td>70h:</td> <td>Thermocouple with ext. cold junction thermostat [K]</td> <td>7,8</td> </tr> <tr> <td>31h:</td> <td>Resistance thermometer 2-wire [K]</td> <td>2,8</td> </tr> <tr> <td>32h:</td> <td>Resistance thermometer 3-wire [K]</td> <td>2,7,8</td> </tr> <tr> <td>54h:</td> <td>Thermocouple with ext. Pt100 on Terminals 1-4 [K]</td> <td>7,8,1,4</td> </tr> <tr> <td>34h:</td> <td>Thermocouple with ext. Pt100 on Terminals 2-8 [K]</td> <td>2,7,8</td> </tr> <tr> <td>11h:</td> <td>Resistance measurement 2-wire [Ω]</td> <td>2,8</td> </tr> <tr> <td>12h:</td> <td>Resistance measurement 3-wire [Ω]</td> <td>2,7,8</td> </tr> <tr> <td>52h:</td> <td>Resistance teletransmitter WF [Ω]</td> <td>2,7,8</td> </tr> <tr> <td>72h:</td> <td>Resistance teletransmitter WFDIN [Ω]</td> <td>2,7,8</td> </tr> <tr> <td>16h:</td> <td>Sensor earthed: Voltage measurement [mV]</td> <td>7,8</td> </tr> <tr> <td>17h:</td> <td>Sensor earthed: TC internally compensated [K]</td> <td>7,8</td> </tr> <tr> <td>76h:</td> <td>Sensor earthed: TC, ext. cold junction thermostat [K]</td> <td>7,8</td> </tr> <tr> <td>50h:</td> <td>2nd current input [mA]</td> <td>6,4</td> </tr> </table> <p>Combination limits are separately shown in a table on page 16.</p>	00h:	Voltage measurement [mV]	Terminal	04h:	Thermocouple internally compensated [K]	3,4	60h:	Thermocouple with ext. cold junction thermostat [K]	3,4	21h:	Resistance thermometer 2-wire [K]	1,4	22h:	Resistance thermometer 3-wire [K]	1,3,4	23h:	Resistance thermometer 4-wire [K]	1,2,3,4	24h:	Thermocouple with ext. Pt100 on Terminals 1-4 [K]	1,3,4	44h:	Thermocouple with ext. Pt100 on Terminals 2-8 [K]	3,4,2,8	01h:	Resistance measurement 2-wire [Ω]	1,4	02h:	Resistance measurement 3-wire [Ω]	1,3,4	03h:	Resistance measurement 4-wire [Ω]	1,2,3,4	42h:	Resistance teletransmitter WF [Ω]	1,3,4	62h:	Resistance teletransmitter WFDIN [Ω]	1,3,4	20h:	Voltage measurement [V]	6,4	40h:	Current measurement [mA]	5,4	06h:	Sensor earthed: Voltage measurement [mV]	3,4	07h:	Sensor earthed: TC internally compensated [K]	3,4	66h:	Sensor earthed: TC, ext. cold junction thermostat [K]	3,4	27h:	Sensor earthed: TC with ext. Pt100 on Terminals 1-4 [K]	1,3,4	10h:	Voltage measurement [mV]	7,8	14h:	Thermocouple internally compensated [K]	7,8	70h:	Thermocouple with ext. cold junction thermostat [K]	7,8	31h:	Resistance thermometer 2-wire [K]	2,8	32h:	Resistance thermometer 3-wire [K]	2,7,8	54h:	Thermocouple with ext. Pt100 on Terminals 1-4 [K]	7,8,1,4	34h:	Thermocouple with ext. Pt100 on Terminals 2-8 [K]	2,7,8	11h:	Resistance measurement 2-wire [Ω]	2,8	12h:	Resistance measurement 3-wire [Ω]	2,7,8	52h:	Resistance teletransmitter WF [Ω]	2,7,8	72h:	Resistance teletransmitter WFDIN [Ω]	2,7,8	16h:	Sensor earthed: Voltage measurement [mV]	7,8	17h:	Sensor earthed: TC internally compensated [K]	7,8	76h:	Sensor earthed: TC, ext. cold junction thermostat [K]	7,8	50h:	2nd current input [mA]	6,4
00h:	Voltage measurement [mV]	Terminal																																																																																																									
04h:	Thermocouple internally compensated [K]	3,4																																																																																																									
60h:	Thermocouple with ext. cold junction thermostat [K]	3,4																																																																																																									
21h:	Resistance thermometer 2-wire [K]	1,4																																																																																																									
22h:	Resistance thermometer 3-wire [K]	1,3,4																																																																																																									
23h:	Resistance thermometer 4-wire [K]	1,2,3,4																																																																																																									
24h:	Thermocouple with ext. Pt100 on Terminals 1-4 [K]	1,3,4																																																																																																									
44h:	Thermocouple with ext. Pt100 on Terminals 2-8 [K]	3,4,2,8																																																																																																									
01h:	Resistance measurement 2-wire [Ω]	1,4																																																																																																									
02h:	Resistance measurement 3-wire [Ω]	1,3,4																																																																																																									
03h:	Resistance measurement 4-wire [Ω]	1,2,3,4																																																																																																									
42h:	Resistance teletransmitter WF [Ω]	1,3,4																																																																																																									
62h:	Resistance teletransmitter WFDIN [Ω]	1,3,4																																																																																																									
20h:	Voltage measurement [V]	6,4																																																																																																									
40h:	Current measurement [mA]	5,4																																																																																																									
06h:	Sensor earthed: Voltage measurement [mV]	3,4																																																																																																									
07h:	Sensor earthed: TC internally compensated [K]	3,4																																																																																																									
66h:	Sensor earthed: TC, ext. cold junction thermostat [K]	3,4																																																																																																									
27h:	Sensor earthed: TC with ext. Pt100 on Terminals 1-4 [K]	1,3,4																																																																																																									
10h:	Voltage measurement [mV]	7,8																																																																																																									
14h:	Thermocouple internally compensated [K]	7,8																																																																																																									
70h:	Thermocouple with ext. cold junction thermostat [K]	7,8																																																																																																									
31h:	Resistance thermometer 2-wire [K]	2,8																																																																																																									
32h:	Resistance thermometer 3-wire [K]	2,7,8																																																																																																									
54h:	Thermocouple with ext. Pt100 on Terminals 1-4 [K]	7,8,1,4																																																																																																									
34h:	Thermocouple with ext. Pt100 on Terminals 2-8 [K]	2,7,8																																																																																																									
11h:	Resistance measurement 2-wire [Ω]	2,8																																																																																																									
12h:	Resistance measurement 3-wire [Ω]	2,7,8																																																																																																									
52h:	Resistance teletransmitter WF [Ω]	2,7,8																																																																																																									
72h:	Resistance teletransmitter WFDIN [Ω]	2,7,8																																																																																																									
16h:	Sensor earthed: Voltage measurement [mV]	7,8																																																																																																									
17h:	Sensor earthed: TC internally compensated [K]	7,8																																																																																																									
76h:	Sensor earthed: TC, ext. cold junction thermostat [K]	7,8																																																																																																									
50h:	2nd current input [mA]	6,4																																																																																																									
			1	FF	<p>Sensor type Input 1 FFh: Linear</p> <table border="0"> <tr> <td>0:</td> <td>RTD Ptxxx (e.g. Pt100)</td> </tr> <tr> <td>1:</td> <td>RTD Nixxx</td> </tr> <tr> <td>2:</td> <td>Customer-specific characteristic curve (only with NLB)</td> </tr> <tr> <td>3:</td> <td>TC Type B</td> </tr> <tr> <td>4:</td> <td>TC Type E</td> </tr> <tr> <td>5:</td> <td>TC Type J</td> </tr> <tr> <td>6:</td> <td>TC Type K</td> </tr> <tr> <td>7:</td> <td>TC Type L</td> </tr> <tr> <td>8:</td> <td>TC Type N</td> </tr> <tr> <td>9:</td> <td>TC Type R</td> </tr> <tr> <td>10:</td> <td>TC Type S</td> </tr> <tr> <td>11:</td> <td>TC Type T</td> </tr> <tr> <td>12:</td> <td>TC Type U</td> </tr> <tr> <td>13:</td> <td>TC Type W5-W26Re</td> </tr> <tr> <td>14:</td> <td>TC Type W3-W25Re</td> </tr> </table> <p><i>Automatic parameter correction²</i></p>	0:	RTD Ptxxx (e.g. Pt100)	1:	RTD Nixxx	2:	Customer-specific characteristic curve (only with NLB)	3:	TC Type B	4:	TC Type E	5:	TC Type J	6:	TC Type K	7:	TC Type L	8:	TC Type N	9:	TC Type R	10:	TC Type S	11:	TC Type T	12:	TC Type U	13:	TC Type W5-W26Re	14:	TC Type W3-W25Re																																																																								
0:	RTD Ptxxx (e.g. Pt100)																																																																																																										
1:	RTD Nixxx																																																																																																										
2:	Customer-specific characteristic curve (only with NLB)																																																																																																										
3:	TC Type B																																																																																																										
4:	TC Type E																																																																																																										
5:	TC Type J																																																																																																										
6:	TC Type K																																																																																																										
7:	TC Type L																																																																																																										
8:	TC Type N																																																																																																										
9:	TC Type R																																																																																																										
10:	TC Type S																																																																																																										
11:	TC Type T																																																																																																										
12:	TC Type U																																																																																																										
13:	TC Type W5-W26Re																																																																																																										
14:	TC Type W3-W25Re																																																																																																										

Address	Description	Data type	#	Default	Description
40524	INPRANGE1	REAL	Measuring range Input 1		
			<i>Variable</i>	<i>Range</i>	<i>Minimum span</i>
			U[mV]:	±0 mV ... 1000 mV	2 mV
			U[V]:	±0 V ... 300 V	1 V
					RTD: Acc. sensor limits
					TC: Acc. sensor limits
					R: 0 ... 5000 [Ω] see special case WF, WFDIN *
					I [mA]: ±0 ... 50 mA 0.2 mA
			<i>Automatic parameter correction²</i>		
			0	0.0 at 2xmA: 4.0	Measuring range start
			1	1000.0 at 2xmA: 20.0	Measuring range end
40528	SCALE1	REAL		1.0	Scaling factor for INPUT1
40530	SENSVAL1	REAL		100.0	Input 1: Sensor value [Ω] at 0°C (e.g. 100.0 for Pt100) Pt20 ... Pt1000 Ni50 ... Ni1000 WF, WFDIN: SENSVAL1=Rd <i>Automatic parameter correction²</i>
40532	REF1	REAL		0.0	Reference value Input 1: – Line resistance [Ω] in 2-wire measurement: 0...30 Ohm – Reference temperature in TC ext. comp.: -20 ... 70 °C <i>Automatic parameter correction²</i>
40534	INPUT2	UINT8	0	FFh at 2xmA: 50h	Type of measurement Input 2 (same as Input 1)
			1	FFh	Sensor type Input 2 (same as Input 1)
40535	INPRANGE2	REAL	Measuring range Input 2 (same as Input 1)		
			0	0.0 at 2xmA: 4.0	Measuring range start
			1	1000.0 at 2xmA: 20.0	Measuring range end
40539	SCALE2	REAL		1.0	Scaling factor for INPUT2
40541	SENSVAL2	REAL		100.0	Input 2: Sensor value [Ω] at 0°C (e.g. 100.0 for Pt100) Pt20 ... Pt1000 Ni50 ... Ni1000 WF, WFDIN: SENSVAL1=Rd <i>Automatic parameter correction²</i>
40543	REF2	REAL		0.0	Reference value Input 2: – Line resistance [Ω] in 2-wire measurement: 0 ... 30 Ohm – Reference temperature [°C] in TC ext. comp.: -20 ... 70 °C
40545	FREQ	REAL		50.0	System frequency [Hz]: 2.5, 5, 10, 15, 25, 30, 50, 60, 100, 500 or 1000 <i>Automatic parameter correction²</i>

*** Resistance teletransmitter**

For teletransmitters the measuring range is defined by 3 resistance values

Input 2: Same as Input 1.

Parameter	Meaning
INPRANGE1, measuring range start	Ra
INPRANGE1, measuring range end	Re
SENSVAL1	Rd

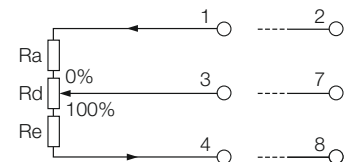
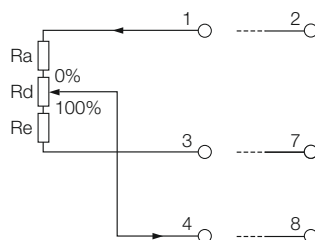

Address	Description	Data type	#	Default	Description
40547	TSET	REAL		1.0	Settling time (99%) [s] 0.01* ... 30 * minimum setting time see "Specified time / setting time" on page 5 <i>Automatic parameter correction</i> ²
40549	SETTING	UINT16		00h	Settings <i>Bit Description</i> 0 Recognition of the type of connection (2L, 3L, 4L) after reset 1 Input 1: Breakage monitoring activated 2 Input 2: Breakage monitoring activated 3 Input 1: Short circuit monitoring activated 4 Input 2: Short circuit monitoring activated
40550	MATRIX	UINT8			Linking of inputs with outputs
			0	01h	Output 1: 00h: Not used 01h: Input 1 02h: Input 2 03h: Input 1 + 2 04h: Input 1 – 2 05h: Input 2 – 1 06h: Input 1 * 2 07h: Minimum value (Input 1,2) 08h: Maximum value (Input 1,2) 09h: Mean value (Input 1,2) 81h: Sensor redundancy: Input 1 normally 82h: Sensor redundancy: Input 2 normally 87h: Sensor redundancy: Minimum value (Input 1,2) 88h: Sensor redundancy: Maximum value (Input 1,2) 89h: Sensor redundancy: Mean value (Input 1,2) Bit 6: Absolute value of the measured variable for the output - Only measured variables of the same unit may be linked. - Product formation: Only possible for combinations V*mV, V*mA, mA*mA, mV*mA and mV*mV. Sensor redundancy - Measured variable in case of a fault: INPUTx which does not show a fault - Limitations: - The same measuring range for both inputs - The same scaling factors (always 1.0) - No output value in case of a fault - Temperature measurement - Breakage or short circuit monitoring active
			1	00h at 2xmA: 02h	Output 2 (same as Output 1)
40551	LIMITA	UINT8			Setting of limit values
			0	0	Measured variable for Limit value 1 <i>Bit Description</i> 0-4 Limit value 0: Not used 1: Input 1 (INPUT1) 2: Input 2 (INPUT2) 3: Measured variable Output 1 (MEAS1) 4: Measured variable Output 2 (MEAS2) 5: Input 1 – Input 2 6: Input 2 – Input 1 6 Absolute value of measured variable for the limit value 7 1: Gradient dx/dt Note: Drift monitoring is realised by difference calculation. Only measured variables of the same unit may be linked.
			1	0	Measure variable for Limit value 2 (same as Limit value 1)
40552	ALARMSETA	UINT8			Relay and alarm (Relay 1)
			0	00h	Relay 1, LED Relay 1 <i>Bit Description</i> 0 Limit value 1 1 Limit value 2 2 Sensor breakage Input 1 or 2 3 Sensor short circuit Input 1 or 2 7 Inverted These settings may all be combined with each other.

Address	Description	Data type	#	Default	Description
			1	00h	Alarm1, LED Alarm <i>Bit Description</i> 0 Limit value 1 1 Limit value 2 2 Sensor breakage Input 1 or 2 3 Sensor short circuit Input 1 or 2 These settings may all be combined with each other.
40553	TON	REAL		0.0	Alarms rise delay [s]: 0..60
40555	TOFF	REAL		0.0	Alarms drop delay [s]: 0..60
40557	TONLIMITA	REAL		0.0	Limit values 1,2: rise delay [s]: 0..3600
40559	TOFFLIMITA	REAL		0.0	Limit values 1,2: drop delay [s]: 0..3600
40561	LIMIT1ON	REAL		0.0	Switching-on threshold Limit value 1, unit of LIMIT1
40563	LIMIT1OFF	REAL		0.0	Switching-off threshold Limit value 1, unit of LIMIT1
40565	LIMIT2ON	REAL		0.0	Switching-on threshold Limit value 2, unit of LIMIT2
40567	LIMIT2OFF	REAL		0.0	Switching-off threshold Limit value 2, unit of LIMIT2
40569	OUTSET1	UINT16		05h at VB604s 01h	Output settings Output 1 <i>Bit Description</i> 0-1 Output limit 0: ± 0 mA or 0 V 1: ± 1 mA or 0.5 V 2: ± 2 mA or 1 V 3: $-0.2/+0.5$ mA or $-0.1/+0.25$ V (e.g. 3.8 mA ... 20.5 mA) 2 Signal flow 0: Interrupted (only possible with VB604s) 1: Activated (V604s) 3 Output configuration 0: Current output Inverting 0: normal , 1: inverted 4 Table 0: without , 1: with table 5 Output in case of a fault 6-7 0: PERCENTx , 1: ERRVALx in case of fault Input 1 2: ERRVALx in case of fault Input 2 3: ERRVALx in case of fault Input 1 or 2 Transmission function 0: User-defined 8-15 1: Linear 2: Quadratic 3: Volume of a horizontal cylinder
40570	OUTRANGE1	REAL			Output range Output 1 <i>Automatic parameter correction²</i> 0 4.0 Minimum value $-20...20$ [mA] / $-10...10$ [V] 1 20.0 Maximum value $-20...20$ [mA] / $-10...10$ [V]
40574	TRIM1	REAL			Output trimming Output 1 <i>Automatic parameter correction²</i> 0 0.0 Offset trimming [in % of the output range, setting range $\pm 10\%$] ¹ 1 100.0 Gain trimming [in % of the output range, setting range 90...110%] ¹
40578	ERRVAL1	REAL		0.0	Output value Output 1 in case of a fault [in % of the output range, setting range $-10...+110\%$] ¹
40580	OUTSET2	UINT16		05h, at VB604s 01h	Output settings Output 2 (same as Output 1)
40581	OUTRANGE2	REAL			Output range Output 2 0 4.0 Minimum value $-20...20$ [mA] / $-10...10$ [V] 1 20.0 Maximum value $-20...20$ [mA] / $-10...10$ [V]
40585	TRIM2	REAL			Output trimming Output 2 0 0.0 Offset trimming [in % of the output range, setting range $\pm 10\%$] ¹ 1 100.0 Gain trimming [in % of the output range, setting range 90...110%] ¹

Address	Description	Data type	#	Default	Description
40589	ERRVAL2	REAL		0.0	Output value Output 2 in case of a fault [in % of the output range, setting range -10...+110%] ¹
40591	GRAD_TIME	REAL		1.0	Time span between two measured values for gradient calculation of limit values in seconds Range: 4 x TSET ... 26210 s <i>Automatic parameter correction</i> ²
40593	NUMTAB	UINT8	Number of table values		
			0	0	Number of table values Table 1 <i>Automatic parameter correction</i> ²
			1	0	Number of table values Table 2 <i>Automatic parameter correction</i> ²
40594	TAB1_YA	REAL		-10.0	Table 1: Y-value (-10%) in % of the measuring range
40596	TAB1_X	REAL[20]		0.0	Table 1: X-values in % of the measuring range
40636	TAB1_Y	REAL[20]		0.0	Table 1: Y-values in % of the measuring range
40676	TAB1_YE	REAL		110.0	Table 1: Y-value (110%) in % of the measuring range
40678	TAB2_YA	REAL		-10.0	Tabelle 1: Y-Wert (-10%) in % vom Messbereich
40680	TAB2_X	REAL[20]		0.0	Tabelle 1: X-Werte in % vom Messbereich
40720	TAB2_Y	REAL[20]		0.0	Tabelle 1: Y-Werte in % vom Messbereich
40760	TAB2_YE	REAL		110.0	Tabelle 1: Y-Wert (110%) in % vom Messbereich
40762 to 40775	Reserved	--		--	Reserved
40776	OFFSET1	REAL		0.0	Offset value for INPUT1, same unit as INPUT1
40778	MEASRANGE1	REAL	Measured value range for output 1 in % of the largest possible measured variable range		
			0	0.0	Measured variable range minimum [%]
			1	100.0	Measured variable range maximum [%] - Requirement: Minimum < maximum
40782	OFFSET2	REAL		0.0	Offset value for INPUT2, same unit as INPUT2
40784	MEASRANGE2	REAL	Measured value range for output 2 in % of the largest possible measured variable range		
			0	0.0	Measured variable range minimum [%]
			1	100.0	Measured variable range maximum [%] - Requirement: Minimum < maximum
40788 to 40792	Reserved	--		--	Reserved

¹ Max. +/-22 mA or +/-11 V

² Automatic correction of parameters in the device.

Each parameter must range within permitted limits. These partly depend on other parameters.

If parameters determining the limits of dependent parameters are changed,

(e.g. measuring range is dependent on the type of measurement), the respective parameters are automatically limited to the permitted parameters. The status will show that such a correction has taken place.

Limitations of configuration parameters

Options to combine types of measurement

Register: 40523, 40534

The numerous types of measurement can be combined with each other in different ways.

See Table 3 p.19

The "earthed" combination is used if both sensors are connected to each other.

Measured variable ranges

Based on linking (register MATRIX), scaling (register SCALE1, 2) and offset (OFFSET1, 2), the largest possible measured variable range is calculated from the measuring ranges (register INPRANGE1, 2). The device does this automatically.

The set measured variable range (register MEASRANGE1, 2), which must be within the calculated measured variable range (zoom function), is then mapped on the analogue output range.

The table values (register TAB1..., TAB2...) refer to the set measured value range.

Abbreviations:

k1: SCALE1 T1a...T1e: INPRANGE1
k2: SCALE2 T2a...T2e: INPRANGE2

MRmin...MRmax: Calculated, largest possible measured variable range

at k1>=0: $Min1 = (T_{1a} + OFFSET1) \times k_1$ $Max1 = (T_{1e} + OFFSET1) \times k_1$

at k2>=0: $Min2 = (T_{2a} + OFFSET2) \times k_2$ $Max2 = (T_{2e} + OFFSET2) \times k_2$

at k1<0: $Min1 = (T_{1e} + OFFSET1) \times k_1$ $Max1 = (T_{1a} + OFFSET1) \times k_1$

at k2<0: $Min2 = (T_{2e} + OFFSET2) \times k_2$ $Max2 = (T_{2a} + OFFSET2) \times k_2$

Matrix Linking of inputs with outputs	Measured variable range																																																														
	Minimum value MRmin	Maximum value MRmax																																																													
Input 1	Min1	Max1																																																													
Input 2	Min2	Max2																																																													
Input 1 + 2	Min1 + Min2	Max1 + Max2																																																													
Input 1 - 2	Min1 - Max2	Max1 - Min2																																																													
Input 2 - 1	Min2 - Max1	Max2 - Min1																																																													
Input 1 * 2																																																															
<table border="1"> <thead> <tr> <th colspan="2">Input 1</th> <th colspan="2">Input 2</th> </tr> <tr> <th>Min1</th> <th>Max1</th> <th>Min2</th> <th>Max2</th> </tr> </thead> <tbody> <tr> <td>≥0</td> <td>>0</td> <td>≥0</td> <td>>0</td> </tr> <tr> <td><0</td> <td>≤0</td> <td>≥0</td> <td>>0</td> </tr> <tr> <td><0</td> <td>>0</td> <td>≥0</td> <td>>0</td> </tr> <tr> <td>≥0</td> <td>>0</td> <td><0</td> <td>≤0</td> </tr> <tr> <td><0</td> <td>≤0</td> <td><0</td> <td>≤0</td> </tr> <tr> <td>>0</td> <td>>0</td> <td><0</td> <td>≤0</td> </tr> <tr> <td>≥0</td> <td>>0</td> <td><0</td> <td>>0</td> </tr> <tr> <td><0</td> <td>≤0</td> <td><0</td> <td>>0</td> </tr> <tr> <td><0</td> <td>>0</td> <td><0</td> <td>>0</td> </tr> </tbody> </table>	Input 1		Input 2		Min1	Max1	Min2	Max2	≥0	>0	≥0	>0	<0	≤0	≥0	>0	<0	>0	≥0	>0	≥0	>0	<0	≤0	<0	≤0	<0	≤0	>0	>0	<0	≤0	≥0	>0	<0	>0	<0	≤0	<0	>0	<0	>0	<0	>0	<table border="1"> <tbody> <tr> <td>Min1 * Min2</td> <td>Max1 * Max2</td> </tr> <tr> <td>Min1 * Max2</td> <td>Max1 * Min2</td> </tr> <tr> <td>Min1 * Max2</td> <td>Max1 * Max2</td> </tr> <tr> <td>Min2 * Max1</td> <td>Min1 * Max2</td> </tr> <tr> <td>Max1 * Max2</td> <td>Min1 * Min2</td> </tr> <tr> <td>Max1 * Min2</td> <td>Min1 * Min2</td> </tr> <tr> <td>Max1 * Min2</td> <td>Max1 * Max2</td> </tr> <tr> <td>Min1 * Max2</td> <td>Min1 * Min2</td> </tr> <tr> <td>Min (Min1 * Max2, Min2 * Max1)</td> <td>Max (Min1 * Min2, Max1 * Max2)</td> </tr> </tbody> </table>	Min1 * Min2	Max1 * Max2	Min1 * Max2	Max1 * Min2	Min1 * Max2	Max1 * Max2	Min2 * Max1	Min1 * Max2	Max1 * Max2	Min1 * Min2	Max1 * Min2	Min1 * Min2	Max1 * Min2	Max1 * Max2	Min1 * Max2	Min1 * Min2	Min (Min1 * Max2, Min2 * Max1)	Max (Min1 * Min2, Max1 * Max2)
Input 1		Input 2																																																													
Min1	Max1	Min2	Max2																																																												
≥0	>0	≥0	>0																																																												
<0	≤0	≥0	>0																																																												
<0	>0	≥0	>0																																																												
≥0	>0	<0	≤0																																																												
<0	≤0	<0	≤0																																																												
>0	>0	<0	≤0																																																												
≥0	>0	<0	>0																																																												
<0	≤0	<0	>0																																																												
<0	>0	<0	>0																																																												
Min1 * Min2	Max1 * Max2																																																														
Min1 * Max2	Max1 * Min2																																																														
Min1 * Max2	Max1 * Max2																																																														
Min2 * Max1	Min1 * Max2																																																														
Max1 * Max2	Min1 * Min2																																																														
Max1 * Min2	Min1 * Min2																																																														
Max1 * Min2	Max1 * Max2																																																														
Min1 * Max2	Min1 * Min2																																																														
Min (Min1 * Max2, Min2 * Max1)	Max (Min1 * Min2, Max1 * Max2)																																																														
Minimum value (Input 1, 2)	Min (Min1, Min2)	Min (Max1, Max2)																																																													
Maximum value (Input 1, 2)	Max (Min1, Min2)	Max (Max1, Max2)																																																													
Mean value (Input 1, 2)	(Min1 + Min2)/2	(Max1 + Max2)/2																																																													
Sensor backup Input 1	Min1 ¹	Max1 ¹																																																													
Sensor backup Input 2	Min2 ¹	Max2 ¹																																																													
Sensor backup minimum value (Input 1, 2)	Min1 ¹	Max2 ¹																																																													
Sensor backup maximum value (Input 1, 2)	Min1 ¹	Max2 ¹																																																													
Sensor backup mean value (Input 1, 2)	Min1 ¹	Max2 ¹																																																													

$${}^1 k_1 = k_2, T_{1a} = T_{2a}, T_{1e} = T_{2e}$$

Matrix= Absolute value of the measured variable -> the previously calculated values (MRmin, MRmax) are rescaled once more:

Matrix	Measured variable range	
	Minimum value MRmin	Maximum value MRmax
Absolute value of the measured variable		
At MRmin, MRmax ≥ 0	MRmin	MRmax
At MRmin < 0, MRmax ≥ 0	0	Max (IMRmin, IMRmax)
At MRmin, MRmax < 0	IMRmax	IMRmin

Linearisation tables

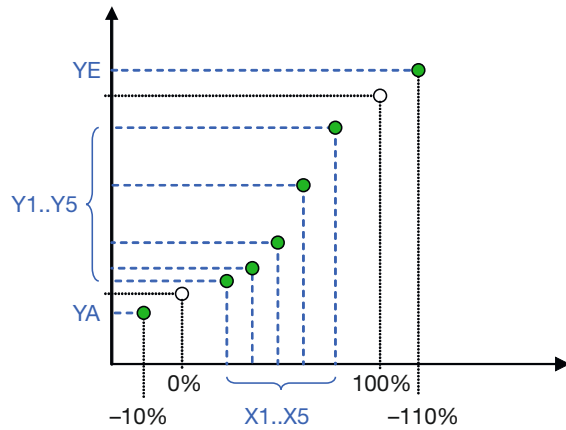

The transmission functions stored in registers OUTSET1 or OUTSET2 constitute information for the PC software to generate the desired transmission function with the table values. This information is irrelevant for the device.

Characteristic curves:

- User-defined, linear, quadratic
- Volume of a horizontal cylinder:

$$y = \frac{1}{\pi} \cdot \left[\arccos(1 - 2x) - 2 \cdot \sqrt{x - x^2} \cdot (1 - 2x) \right] \quad (h/2r = x = 0..1, y = 0..1)$$

7. Electric connections

	Circuit	Terminals	Remarks
	Measuring input	1 to 8	See Table 2, page 18
	Output 1 Output 2	11 (+), 12 (-) 10 (+), 12 (-)	
	Relay contact	9, 13	
	Power supply	15 (+/~) 16 (-/~)	Note polarity at DC
	Bus-/pro-gramming connection	+, -, GND	Front plug

Wiring with 2 input sensors

If 2 input sensors or input variables are used, observe combination options in Table 3!

Beschaltung
Eingang 1 und 2

All Inputs max. 300V CATIII

If 2 input sensors or input variables are used, these must be free of potential or galvanically isolated against each other, on principle! Otherwise, the transmitter may be damaged.

Exceptions:

- In case of a permitted input combination¹ with common (and approved) connections on Terminal 4.
E.g. direct voltage mV (Terminal 3, 4) & direct voltage V (Terminal 6, 4)
- In case of a permitted input combination¹ with the same reference potential (e.g. earth) on Terminal 4 and 8
E.g. 2 thermocouples (on Terminals 3, 4 or 7, 8) with earthed sensor tips or two mV inputs with a common earth potential on Terminals 4 and 8.
In these cases, the specified types of measurement must be configured for earthed sensors.

¹ See Table 3 "Options to combine types of measurement" page 19

Table 2: Connections of inputs

Types of measurement	Wiring	
	Input 1	Input 2
Direct voltage mV		
Thermocouple with external cold junction thermostat or internally compensated		
Thermocouple with Pt100 at the terminals at the same input		

Types of measurement	Wiring	
	Input 1	Input 2
Thermocouple with Pt100 at the terminals at the other input		
Resistance thermometer or resistance measurement 2-wire		
Resistance thermometer or resistance measurement 3-wire		
Resistance thermometer or resistance measurement 4-wire		
Resistance teletransmitter WF		
Resistance Teletransmitter WF-DIN		
Direct voltage mA		

Table 3: Measuring method combination options

Input 1 measuring method	Input 2 measuring method	U [mV]		TC ext.		TC int.		R 2L	R 3L	RTD 2L	RTD 3L	I [mA]
		earthed	not earthed	earthed	not earthed	earthed	not earthed					
Terminals		7,8		7,8		7,8	2,7,8	2,8	2,7,8	2,8	2,7,8	6,4
U [mV]	3,4	✓	✓	✓	✓	✓	✓	✓	✓	✓	✓	✓
earthed			✓		✓							
I [mA]	5,4	✓	✓	✓	✓	✓	✓	✓	✓	✓	✓	✓
TC ext.	3,4	✓	✓	✓	✓	✓	✓	✓	✓	✓	✓	✓
earthed			✓		✓							
TC int.	3,4	✓	✓	✓	✓	✓	✓	✓	✓	✓	✓	✓
earthed			✓		✓							
	1,3,4	✓	✓			✓	✓	✓	✓	✓	✓	
R 2L	1,4	✓	✓			✓	✓	✓	✓	✓	✓	
R 3L	1,3,4	✓	✓			✓	✓	✓	✓	✓	✓	
R 4L	1,2,3,4	✓	✓									
RTD 2L	1,4	✓	✓			✓	✓	✓	✓	✓	✓	
RTD 3L	1,3,4	✓	✓			✓	✓	✓	✓	✓	✓	
WF	1,3,4	✓	✓			✓	✓	✓	✓	✓	✓	
WF_DIN	1,3,4	✓	✓			✓	✓	✓	✓	✓	✓	
RTD 4L	1,2,3,4	✓	✓									

8. Dimensional drawing

With screw terminals

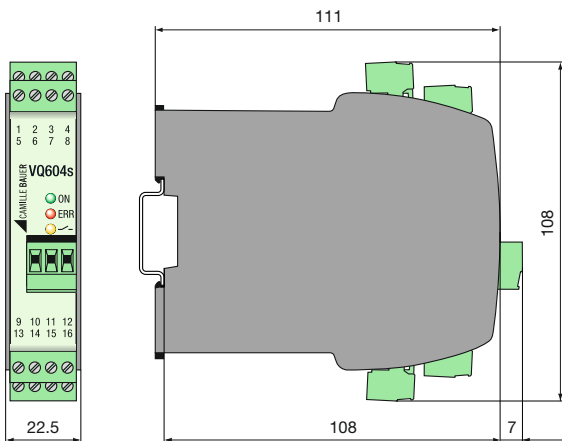

With spring cage terminals

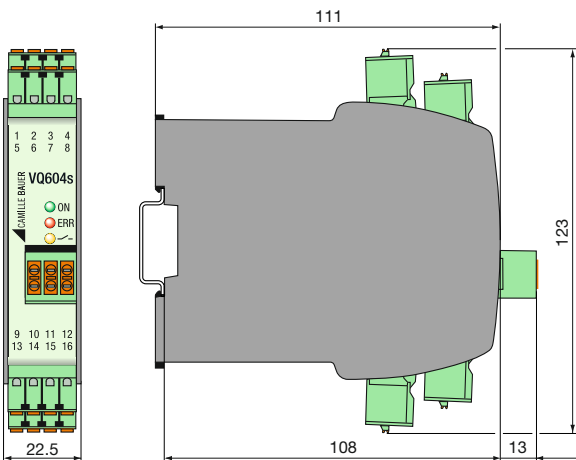

9. Accessories

USB-RS485 converter
(for SINEAX V604s programming): Article No. 163 189

10. Conformity declaration

EG - KONFORMITÄTSERKLÄRUNG EC DECLARATION OF CONFORMITY		CAMILLE BAUER
Dokument-Nr. / Document.No.: VQ604s_CE-konf.DOC		
Hersteller / Manufacturer: Camille Bauer AG Switzerland		
Anschrift / Address: Aargauerstrasse 7 CH-5610 Wohlen		
Produktbezeichnung / Product name: Programmierbarer multifunktionaler Messumformer Programmable multifunctional transmitter		
Typ / Type: Sineax VQ604s		
Das bezeichnete Produkt stimmt mit den Vorschriften folgender Europäischer Richtlinien überein, nachgewiesen durch die Einhaltung folgender Normen:		
The above mentioned product has been manufactured according to the regulations of the following European directives proven through compliance with the following standards:		
Nr. / No.	Richtlinie / Directive	
2004/108/EG 2004/109/EC	Elektromagnetische Verträglichkeit - EMV-Richtlinie Electromagnetic compatibility - EMC directive	
EMV / EMC	Fachgrundnorm / Generic Standard	Messverfahren / Measurement methods
Störaussendung / Emission	EN 61000-6-4 : 2007	EN 55011 : 2007+A2:2007
Störfestigkeit / Immunity	EN 61000-6-2 : 2005	IEC 61000-4-2: 1995+A1:1998+A2:2001 IEC 61000-4-3: 2006+A1:2007 IEC 61000-4-4: 2004 IEC 61000-4-5: 2005 IEC 61000-4-6: 2008 IEC 61000-4-11: 2004
Nr. / No.	Richtlinie / Directive	
2006/95/EG 2006/95/EC	Elektrische Betriebsmittel zur Verwendung innerhalb bestimmter Spannungsgrenzen - Niederspannungsrichtlinie - CE-Kennzeichnung : 95 Electrical equipment for use within certain voltage limits - Low Voltage Directive - Attachment of CE marking : 95	
EN/Norm/Standard	IEC/Norm/Standard	
EN 61010-1: 2010	IEC 61010-1: 2010	
Ort, Datum / Place, date:		Wohlen, 16. Januar 2012
Unterschrift / signature:		
 M. Ulrich Leiter Technik / Head of engineering		 J. Brem Qualitätsmanager / Quality manager