



# Modbus/RTU interface *APLUS*

Camille Bauer Metrawatt AG  
CH-5610 Wohlen

Camille Bauer Metrawatt AG reserves the right to change  
the content of this document at any time without notice.



## Content

<b>1</b>	<b>EIA-RS-485 Standard .....</b>	<b>2</b>
1.1	Coding .....	2
1.2	Connections .....	2
1.3	Topology.....	2
1.4	System requirements .....	2
<b>2</b>	<b>Coding and addressing .....</b>	<b>3</b>
<b>3</b>	<b>Mapping .....</b>	<b>5</b>
3.1	Address space.....	5
3.2	Used addresses .....	6
3.3	Used Syntax .....	7
<b>4</b>	<b>Device information.....</b>	<b>8</b>
4.1	Hardware and firmware .....	8
4.2	Device state.....	9
4.3	Device identification .....	9
4.4	Measurement input configuration .....	10
4.5	General.....	11
<b>5</b>	<b>Measurements .....</b>	<b>12</b>
5.1	General instantaneous values.....	12
5.2	System analysis.....	13
5.2.1	Instantaneous values of harmonic analysis .....	13
5.2.2	Instantaneous values of imbalance analysis.....	14
5.2.3	Instantaneous values of reactive power analysis.....	14
5.3	Minimum / maximum values of system quantities.....	15
5.4	Minimum / maximum values of system analysis .....	16
5.4.1	Maximum values of harmonic analysis .....	16
5.4.2	Maximum values of imbalance analysis.....	17
5.4.3	Maximum values of reactive power analysis.....	17
5.5	Mean-values, trends, minimum / maximum values .....	18
5.5.1	Mean values of power (standard quantities).....	18
5.5.2	Free configurable mean-value quantities.....	18
5.6	Instantaneous values of analog outputs.....	19
5.7	Present state of limit values .....	19
5.8	Free scalable 16-Bit Modbus image.....	19
5.9	Free selectable Modbus image .....	19
5.10	Present state of logic functions .....	20
5.11	Present states of digital I/O's .....	23
<b>6</b>	<b>Energy meters .....</b>	<b>24</b>
6.1	General.....	24
6.2	Meter contents of standard quantities .....	24
6.3	Meter contents of I/O meters.....	25
6.4	Present tariff of meters.....	25
<b>7</b>	<b>Operating hour counters.....</b>	<b>26</b>
<b>8</b>	<b>Modbus interface .....</b>	<b>27</b>
<b>9</b>	<b>Simulation mode .....</b>	<b>28</b>
9.1	Simulation of digital outputs, Relays and LED's.....	29
9.2	Simulation of analog outputs.....	30
9.3	Simulation of logical functions.....	31
<b>10</b>	<b>Remote interface .....</b>	<b>32</b>

The basics of the **MODBUS®** communication are summarized in the document "**Modbus Basics. PDF**"  
(see documentation CD or on our website <http://www.camillebauer.com>)

Modificat.	Date	Vis.:	Type:	<i>APLUS</i>	Page:	1 / 32	Author:	22.10.10 RR
2014-018	04.06.14	RR	Description:	<b>Modbus interface</b>	No.:	W 157 695		

# 1 EIA-RS-485 Standard

The EIA-RS 485 standard defines the physical layer of the Modbus interface.

## 1.1 Coding

The data will be transferred serially via the 2-wire bus. The information is coded in NRZ code as a differential signal. The positive polarity signals a logical 1, the negative polarity signals a logical 0.

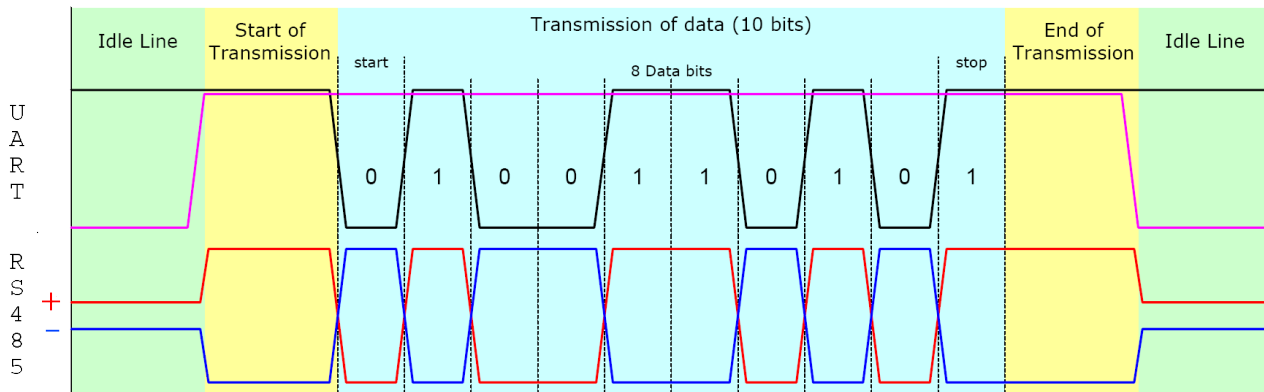

## 1.2 Connections

We recommend to use shielded and twisted two-wire bus cable. Shielding improves the electromagnetic compatibility (EMC). The notation of the wires A resp. B are contradictory depending on the information source.

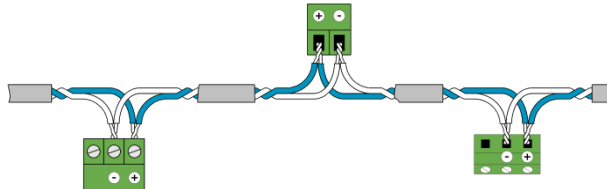

The potential difference of all bus members must not exceed  $\pm 7V$ . Therefore the use of a shield or of a third wire (ref line) for potential equalization is recommended.

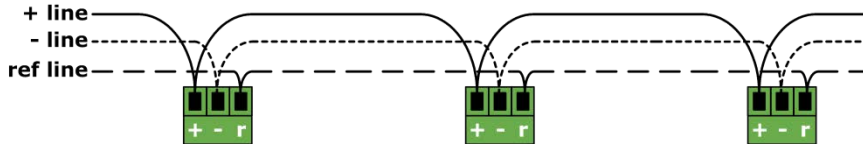

## 1.3 Topology

On both ends of the bus cable a termination resistor must be provided. In addition to the bus termination resistors a resistor  $R_U$  (Pull-up) must be connected to the supply voltage and a resistor  $R_D$  (Pull down) to the reference potential. By means of these two resistors a defined idle state of the line is ensured if no bus member is sending data.

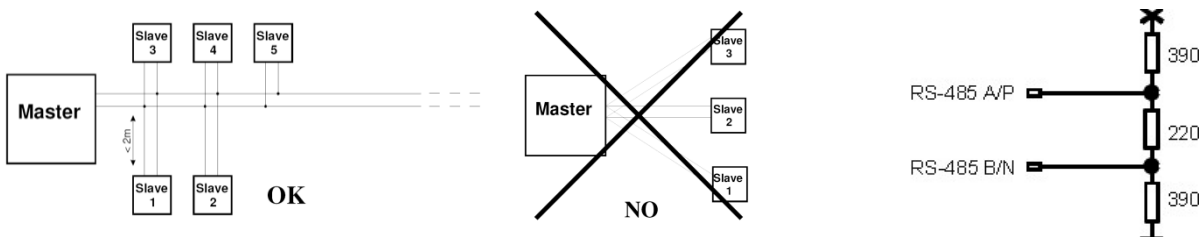

## 1.4 System requirements

- Cable : twisted 2-wire line, characteristic impedance 100 up to 130  $\Omega$ , min. 0.22mm<sup>2</sup> (24AWG)
- Cable length : maximum of 1'200m, depending on the transfer rate
- Members : maximum of 32 per segment
- Baud rate : 2'400, 4'800, 9'600, 19'200, 38'400, 57'600, 115'200 Baud
- Mode : 11 Bit format - 2 stop bits, no parity or 1 stop bit with odd/even parity  
10 Bit format - 1 stop bit, no parity (possible, but not in accordance with Modbus standard)

Modificat.	Date	Vis.:	Type:	APLUS	Page:	2 / 32	Author:	22.10.10 RR
2014-018	04.06.14	RR	Description:	<b>Modbus interface</b>	No.:	W 157 695		

## 2 Coding and addressing

### Addressing

Modbus groups different data types as references. The telegram functions 03H (Read Holding Register) and 10H (Preset Multiple Registers) e.g. use register addresses starting at 40001. The reference 4xxxx is implicit, i.e. is given by the used telegram function. Therefore for addressing the leading 4 is omitted. Another specialty in Modbus telegrams: The register numeration starts at 1, but the addressing starts at 0.

Example: Measurement U1N on register address 40102

- Address declaration (see chapter 5.1): 40102
- Real address: 102 (offset 1)
- Address used in telegram: 101 (offset 0)

### Serializing

The Modbus specification defines the telegrams to be sequences of data bytes. For the correct serializing of the bytes (MSB or LSB First), the appropriate physical layer (RS485, Ethernet) is responsible. The RS485 (UART, COM) transmits the „Least Significant Bit“ first (LSB First) and adds the synchronization and parity bits (start bit, parity bit and stop bit).

Start	1	2	3	4	5	6	7	8	Par	Stop
-------	---	---	---	---	---	---	---	---	-----	------

### Reading bit information: Function 0x01, Read Coil Status

Bits are represented within a byte in a conventional way, MSB (Bit 7) on the most left and LSB (Bit 0) most right (0101'1010 = 0x5A = 90).

Example: Reading coil 1 up to 11 of device 17:

Byte	Request		Answer	
1	Slave address	0x11	Slave address	0x11
2	Function code	0x01	Function code	0x01
3	Start address	0x00	Byte count	0x02
4	0 = Coil 1	0x00	Byte 1	<b>0x53</b>
5	Number of registers:	0x00	Byte 2	<b>0x03</b>
6	1...11 = 11	0x0B	Checksum	crc_l
7	Checksum	crc_l	CRC16	crc_h
8	CRC16	crc_h		

The start address of the request plus the bit position in the answer byte 0 corresponds to the coil address. Started bytes are filled with zeros.

	Hex	Binary	Coil 8	Coil 7	Coil 6	Coil 5	Coil 4	Coil 3	Coil 2	Coil 1
Byte 1	0x53	01010011b	OFF	ON	OFF	ON	OFF	OFF	ON	ON
	Hex	Binary	-	-	-	-	-	Coil 11	Coil 10	Coil 9
Byte 2	0x03	0000011b	-	-	-	-	-	OFF	ON	ON

Modificat.	Date	Vis.:	Type:	<i>APLUS</i>	Page:	3 / 32	Author:	22.10.10 RR
2014-018	04.06.14	RR	Description:	<b>Modbus interface</b>	No.:	W 157 695		

## Reading byte information

Modbus does not know a data type Byte or Character (see address space). Strings or byte arrays will be mapped into holding registers (2 bytes per register) und transferred as „Character streams“.

Example: Device description text on address 42098 and following (terminated by 0)

Byte	Request		Answer		
1	Slave address	0x11	Slave address	0x11	
2	Function code	0x03	Function code	0x03	
3	Start address:	0x08	Byte count	0x06	
4	(2098-1)	0x31	Byte 1	<b>0x50</b>	,P'
5	Number of registers:	0x00	Byte 2	<b>0x41</b>	,A'
6	3	0x03	Byte 3	<b>0x55</b>	,U'
7	Checksum	crc_l	Byte 4	<b>0x4C</b>	,L'
8	CRC16	crc_h	Byte 5	<b>0x00</b>	0
9			Byte 6	<b>0x53</b>	,S'
10			Checksum	crc_l	
11			CRC16	crc_h	

Example: MAC address of the Ethernet card on addresses 40024 and 40029 of device 17

Byte	Request		Answer	
1	Slave address	0x11	Slave address	0x11
2	Function code	0x03	Function code	0x03
3	Start address:	0x00	Byte count	0x0C
4	(24-1)	0x17	Byte 1	<b>0x12</b>
5	Number of registers:	0x00	Byte 2	<b>0x00</b>
6	3	0x03	Byte 3	<b>0xAE</b>
7	Checksum	crc_l	Byte 4	<b>0x34</b>
8	CRC16	crc_h	Byte 5	<b>0xD5</b>
9			Byte 6	<b>0x00</b>
10			Checksum	crc_l
11			CRC16	crc_h

➤ MAC address: **00-12-34-AE-00-D5**

## Reading single registers: Function 0x03, Read Holding Register

Register or words will be transferred in accordance with the „Big Endian“ format.

Example: Reading U1N harmonics (2nd up to 5th) on register addresses 40250 up to 40253 of slave 17

Byte	Request		Answer		
1	Slave address	0x11	Slave address	0x11	
2	Function code	0x03	Function code	0x03	
3	Start address:	0x00	Byte count	0x08	
4	(250-1)	0xF9	Byte 1	<b>0x00</b>	Hex. Dec.
5	Number of registers:	0x00	Byte 2	<b>0x06</b>	2 <sup>nd</sup> harmonic 0x0006: 06 ‰ = 0,6%
6	4	0x04	Byte 3	<b>0x00</b>	
7	Checksum	crc_l	Byte 4	<b>0x32</b>	3 <sup>rd</sup> harmonic 0x0032: 50 ‰ = 5,0%
8	CRC16	crc_h	Byte 5	<b>0x00</b>	
9			Byte 6	<b>0x12</b>	4 <sup>th</sup> harmonic 0x0012: 18 ‰ = 1,8%
10			Byte 7	<b>0x00</b>	
11			Byte 8	<b>0x25</b>	5 <sup>th</sup> harmonic 0x0025: 37 ‰ = 3,7%
12			Checksum	crc_l	
13			CRC16	crc_h	

Modificat.	Date	Vis.:	Type:	APLUS	Page:	4 / 32	Author:	22.10.10 RR
2014-018	04.06.14	RR	Description:	<b>Modbus interface</b>	No.:	W 157 695		

## Reading float numbers (REAL): Function 0x03, Read Holding Register

There is no representation for floating point numbers in the Modbus specification. But as a matter of principle any desired data structure can be casted to a sequence of 16Bit registers.

The IEEE 754 Standard as the most often used standard for the representation of floating numbers is normally applied.

- The first register contains the bits 0 – 15 of the 32 bit number (bit 0...15 of the mantissa).
- The second register contains the bits 16 – 31 of the 32 bit number (sign, exponent and bit 16-22 of the mantissa).

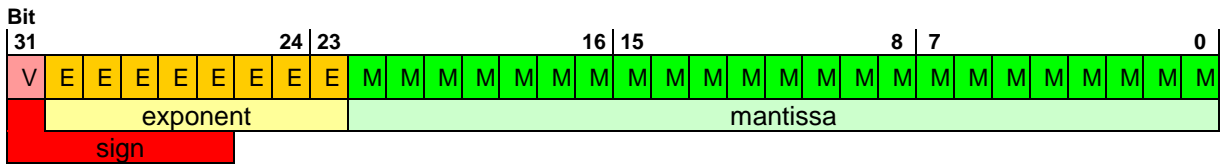

Example: Reading voltage U1N on register address 40102 of device 17.

Byte	Request		Answer	
1	Slave address	0x11	Slave address	0x11
2	Function code	0x03	Function code	0x03
3	Start address (102-1)	0x00	Byte Count	0x04
4		0x65	Byte 1	<b>0xE8</b>
5	Number of registers:	0x00	Byte 2	<b>0x78</b>
6		2	0x02	Byte 3
7	Checksum	crc_l	Byte 4	<b>0x6B</b>
8	CRC16	crc_h	Checksum	crc_l
9			CRC16	crc_h

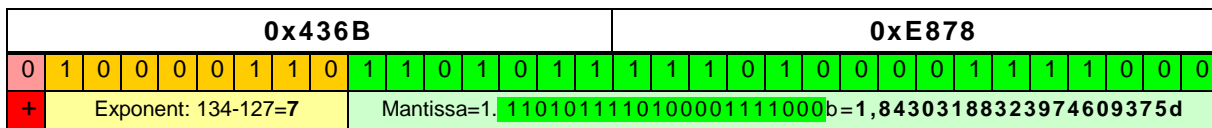

➤ **U1N = +1,84303188323974609375 \* 2<sup>7</sup> = 234,908V**

## 3 Mapping

### 3.1 Address space

The address space may be divided in 4 address spaces in accordance with the 4 data types.

Space	Access	Address range	Function code	
Coil	readable / writable	00001 – 09999	0x01 0x05 0x0F	Read Coil Status Force Single Coil Force Multiple Coils
Discrete input	read only	10001 – 19999	0x02	Read Input Status <sup>1)</sup>
Input register	read only	30001 – 39999	0x04	Read Input Register <sup>1)</sup>
Holding register	readable / writable	40001 – 49999	0x03 0x06 0x10	Read Holding Register Force Single Register <sup>1)</sup> Preset Multiple Register

1) not implemented

To reduce the number of commands the device image has been mapped using „Holding register“ if possible. Quantities normally addressed as a single bit information are implemented as „Coil“ or „Discrete input“.

Modificat.	Date	Vis.:	Type:	APLUS	Page: 5 / 32	Author: 22.10.10 RR
2014-018	04.06.14	RR	Description:	<b>Modbus interface</b>	No.:	W 157 695

### 3.2 Used addresses

Address	# Reg.	Description	Access
40001 - 40034	33	Device information	R
40100 - 40211	112	Instantaneous values general	R
40216 - 40247	32	Instantaneous values of harmonic analysis	R
40250 - 40621	372	Instantaneous values of harmonics	R
40630 - 40805	176	Minimum / maximum values of power system quantities	R
40810 - 41223	414	Maximum values of THD, TDD and harmonics	R
41236 - 41519	284	Mean-values	R
41520 - 41526	7	Instantaneous values of analog outputs	R
41530 - 41530	1	States of limit values	R
41648 - 41657	10	Instantaneous values RTC and operating hour counters	R
41660 - 41691	24	Reactive power, measurements of fundamental	R
41800 - 41819	20	16-Bit measurement quantities	R
41840 - 41960	121	Free selectable measurements	R
43918 - 43922	5	States of logic functions	R
43930 - 43977	48	Reactive power, measurements of fundamental, min/max values	R
44153 - 44164	12	Last events of data logger	R
41540 - 41579	40	Meter contents and scaling factors of I/O meters	RW
41580 - 41628	49	Meter contents and scaling factors of standard quantities	RW
41629 - 41629	1	Tariff of meters	RW
41640 - 41647	8	Parameters of the RTC	RW
41700 - 41702	3	Simulation mode	RW
42000 - 42003	4	Settings Modbus X4	RW
42020 - 42052	33	Settings of the security system	RW
42095 - 42137	43	Common device settings	RW
42200 - 42217	18	Parameters of measurement input	RW
42300 - 42343	44	Parameters of digital inputs, relays and digital outputs	RW
42350 - 42429	80	Parameters of analog outputs	RW
42450 - 42473	24	Parameters of standard meters	RW
42600 - 42615	16	Parameters of mean-values	RW
42700 - 42779	80	Parameters of limit values	RW
43100 - 43212	113	Parameters of logic module	RW
43300 - 43359	60	Parameters of free configurable 16-Bit quantities	RW
43400 - 43459	60	Parameters of free selectable measurements	RW
43923 - 43923	1	Logic functions: BUS presetting	RW
43924 - 43924	1	Logic functions: Simulation	RW
44000 - 44014	15	Parameters of RMS disturbance recorder	RW
44100 - 44152	53	Parameters of loggers	RW
44400 - 44525	126	Parameters of display	RW
44900 - 44910	11	Parameters of Ethernet interface	RW
44954 - 44957	4	Settings Modbus X8	RW
48000 - 48162	163	Calibration parameters	RW
48170 - 48175	6	Calibration parameters measurements	R
1 - 11		Digital I/O's	R
1 - 11		Digital I/O's (remote interface)	RW
13 - 16		States of LED's (remote interface)	RW
20 - 22		Reset operating hour counters	W
50 - 73		Start, stop, reset of loggers	RW
200 - 203		Alarm acknowledgment	W
500 - 543		Reset of min/max values of system quantities	W
670 - 682		Reset of min/max values of THD, TDD, harmonics	W
700 - 711		Reset of min/max values of reactive power analysis	W
1030 - 1067		Reset of min/max values of mean-values	W
1410 - 1423		Reset of min/max values of I/O meters	W
1460 - 1483		Reset of min/max values of standard quantity meters	W

**Access:** R = readable, W = writable

Modificat.	Date	Vis.:	Type:	APLUS	Page: 6 / 32	Author: 22.10.10 RR
2014-018	04.06.14	RR	Description:	<b>Modbus interface</b>	No.: W 157 695	

### 3.3 Used Syntax

<b>Address</b>	Start address of described data block (Register, Coil or Input Status)
<b>Time</b>	Register address of a timestamp, typically of a minimum / maximum value
<b>Value</b>	Register address of a measured quantity, typically of a minimum / maximum value
<b>Reset coil</b>	Coil register address to reset a corresponding measured quantity
<b>Name</b>	Unique name of a variable or structure
<b>Type</b>	<b>Data type of variable</b> U: unsigned INT: integer with 8, 16 or 32 Bit REAL (float) CHAR[.]: String with/without termination (NULL) TIME: seconds since 1.1.1970 COIL: Bit information
<b>Default</b>	Value when delivering, after a hardware reset or if quantity is not available
<b>Description</b>	Exact description of variable
<b>14</b>   <b>2L</b>   <b>3G</b>   <b>3U</b>   <b>3A</b>   <b>4U</b>   <b>4O</b>	Availability of the measured quantities, depending on the connected system
	<b>14</b> = Single phase system or 4-wire balanced load <b>2L</b> = two phase system (split phase) <b>3G</b> =3-wire balanced load <b>3U</b> =3-wire unbalanced load <b>3A</b> =3-wire balanced load, Aron connection <b>4U</b> =4-wire unbalanced load <b>4O</b> =4-wire unbalanced load, Open-Y connection

Modificat.	Date	Vis.:	Type:	<i>APLUS</i>	Page: 7 / 32	Author: 22.10.10 RR
2014-018	04.06.14	RR	Description:	<b>Modbus interface</b>	No.: W 157 695	

## 4 Device information

### 4.1 Hardware and firmware

Address	Name	Type	#	Default	Description
40001	HW_IO_INFO	UINT8			<b>Type of available I/O channels</b>
			0	54h	Basic unit I/O 1 (Relay)
			1	03h	Basic unit I/O 2 (Digital input 24 V)
			2	04h	Basic unit I/O 3 (Digital input 24 V)
			3	FFh	Extension card I/O 4 (Relay)
			4	FFh	Extension card I/O 5 (Relay)
			5	FFh	Extension card I/O 6 (Digital I/O 24 V)
			6	FFh	Extension card I/O 7 (Digital I/O 24 V)
			7	FFh	Extension card I/O 8 (var.)
			8	FFh	Extension card I/O 9 (var.)
			9	FFh	Extension card I/O 10 (var.)
			10	FFh	Extension card I/O 11 (var.)
			11	FFh	Reserved

The configuration of I/Os bases upon the structure shown opposite.

The value FFh is used for, which does not exist.

Possible extension cards:

- None used
- 2 Relays + 6 Digital I/Os
- 2 Relays + 2 Digital I/Os + 4 analog outputs

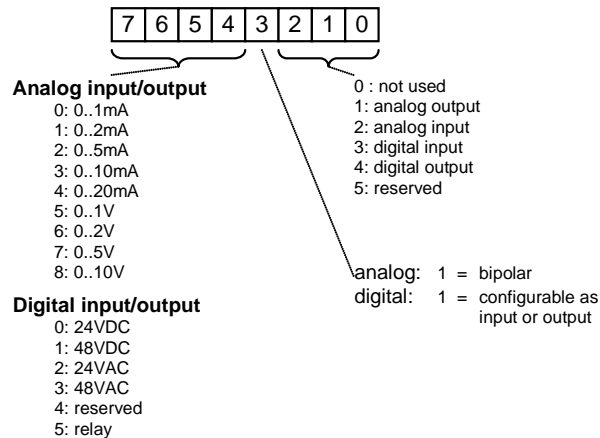

Address	Name	Type	#	Default	Description																						
40007	HW_OPTIONS	UINT32		0x00	<table border="1"> <thead> <tr> <th>Bit</th> <th>Meaning</th> </tr> </thead> <tbody> <tr><td>0</td><td>Logger</td></tr> <tr><td>1</td><td>Display Unit LED</td></tr> <tr><td>2</td><td>Extension Unit</td></tr> <tr><td>3</td><td>Display unit TFT</td></tr> <tr><td>4</td><td>Current measurement via Rogowski coils</td></tr> <tr><td>:</td><td></td></tr> <tr><td>8</td><td>Ethernet (Modbus/TCP), no Modbus/RTU X4</td></tr> <tr><td>9</td><td>Profibus DP + Modbus/RTU X4</td></tr> <tr><td>:</td><td></td></tr> <tr><td>12</td><td>Modbus interface X8</td></tr> </tbody> </table>	Bit	Meaning	0	Logger	1	Display Unit LED	2	Extension Unit	3	Display unit TFT	4	Current measurement via Rogowski coils	:		8	Ethernet (Modbus/TCP), no Modbus/RTU X4	9	Profibus DP + Modbus/RTU X4	:		12	Modbus interface X8
Bit	Meaning																										
0	Logger																										
1	Display Unit LED																										
2	Extension Unit																										
3	Display unit TFT																										
4	Current measurement via Rogowski coils																										
:																											
8	Ethernet (Modbus/TCP), no Modbus/RTU X4																										
9	Profibus DP + Modbus/RTU X4																										
:																											
12	Modbus interface X8																										
40009	NLB_NR	UINT16		0	NLB number. If not 0 the device is a special version (hardware- and / or firmware)																						
40010	FW_MU	UINT32		0	Firmware version measurement unit <table border="1"> <thead> <tr> <th>Byte 3</th> <th>Byte 2</th> <th>Byte 1</th> <th>Byte 0</th> </tr> </thead> <tbody> <tr> <td colspan="4" style="text-align: center;"><b>V1.00. XXXX</b></td> </tr> </tbody> </table>	Byte 3	Byte 2	Byte 1	Byte 0	<b>V1.00. XXXX</b>																	
Byte 3	Byte 2	Byte 1	Byte 0																								
<b>V1.00. XXXX</b>																											
40012	FV_CU	UINT32		0	Firmware version analysis unit (format as meas.unit)																						
40014	FV_BU	UINT32		0	Firmware version communication card (as meas.unit)																						
40016	FV_XU	UINT32		0	Firmware version I/O extension card (as meas.unit)																						
40018	FV_DU	UINT32		0	Firmware version display																						
40020	HW_FREQ	REAL		55.0	Calibration frequency in Hz																						

Modificat.	Date	Vis.:	Type:	APLUS	Page:	8 / 32	Author:	22.10.10 RR
2014-018	04.06.14	RR	Description:	<b>Modbus interface</b>	No.:	W 157 695		

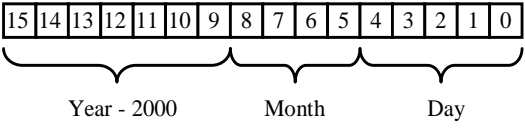
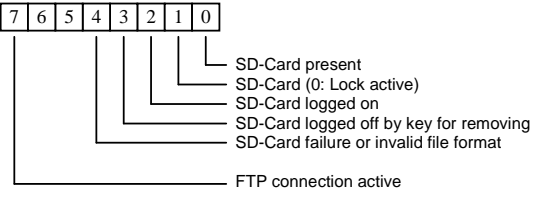

Address	Name	Type	#	Default	Description
40022	SERIAL_NR	UINT32		0	Serial number / sequence number basic unit - High register:  - Low register: sequence number
40024	MAC	UINT8	0 1 2 3 4 5	00h 12h 34h AEh 00h 00h	MAC address (if Ethernet interface available) e.g. 001234AExxxx 001234 - Identification Camille Bauer AE - Device identification <i>APLUS</i> xxxx - Sequence number
40027	MEM_INFO	UINT8	0 1	0 0	Infos memory card and FTP (with option Logger only) 
			1	0	reserved

#### 4.2 Device state

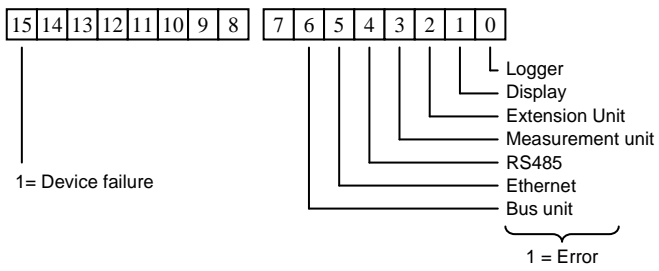
Address	Name	Type	Default	Description
40030	DEV_STATUS	UINT16	0	Device state 

#### 4.3 Device identification

The type of the connected device may be identified using the function **Report Slave ID** (0x11).

Device address	Function	CRC	
ADDR	0x11	Low-Byte	High-Byte

Device answer:

Device address	Function	#Bytes	Device ID	Data1	Data2	CRC	
ADDR	0x11	3	<sid>			Low-Byte	High-Byte

0x01	VR660	Temperature controller
0x02	A200R	Display unit for temperature controller
0x03	CAM	Measurement unit for power quantities
0x04	<i>APLUS</i>	Multifunctional display unit
0x05	V604s	Universal transmitter
0x06	V620	Universal converter

The values for Data1 and Data2 are reserved for future extensions.

Modificat.	Date	Vis.:	Type:	<i>APLUS</i>	Page:	9 / 32	Author:	22.10.10 RR
2014-018	04.06.14	RR	Description:	<b>Modbus interface</b>	No.:	W 157 695		

#### 4.4 Measurement input configuration

Address	Name	Type	#	Default	Description
42200	INPUT_SYS	UINT8	0	04h	System configuration <u>Value</u> <u>Meaning</u> 0x00 Single phase system 0x05 two phase system (split phase) 0x01 3-wire system, balanced load 0x13 3-wire system, unbalanced load 0x03 3-wire system, unbalanced load, Aron connection 0x02 4-wire system, balanced load 0x04 4-wire system, unbalanced load 0x14 4-wire system, unbalanced load, Open-Y connection
			1	0	<u>Value</u> <u>Frequency range</u> <u>Calibration frequency</u> 0 45 ... 65 Hz 55 Hz
42201	INPUT_CFG	UINT16	0	010Ah	Settings <u>Bit</u> <u>Meaning</u> <u>0</u> <u>1</u> 0, 1 Freq.measurement 0 Voltage via... 1 Current 2 <b>automatically</b> 2 Sampling freq. <b>adaptive</b> fix 3 Rotation left-hand <b>right-hand</b> 4 Quadrant <b>L-C-L-C</b> L-L-C-C ind-cap-ind-cap ind-ind-cap-cap 5 not used 6 Freq.measurement <b>filtered</b> fast 7 Autoscale U <b>Off</b> On 8 Autoscale I Off <b>On</b>
					42202
42204	IN_VOLTAGE	REAL	0	400.0	Nominal voltage primary (L-L) V (50 ... 1000E6)
42206			1	400.0	Nominal voltage secondary (L-L) V (50 ... 832)
42208	IN_CURRENT	REAL	0	5.0	Nominal current primary A (0.1 ... 200E3) (CB-Manager limits on 1...200E3)
42210			1	5.0	Nominal current secondary A (0.1 ... 10) (CB-Manager limits on 0.1...7.5A)
42212	IN_VOLT_MAX	REAL	0	832.0	maximum voltage secondary ( L-L) V (50 ... 832)
42214	IN_CURR_MAX	REAL	0	7.5	maximum current secondary A (0.1 ... 10) (CB-Manager limits on 0.1...7.5A)
42216	EFF_MEAN_TP	UINT16	0	8	RMS values averaging over 2, 4, 6, 8, 10 ... 1024 cycles
42217	IB_MEAN_TP	UINT16	0	15	Low-pass filter time constant for bimetal current: 1.. 60 [min]

#### Device version with Rogowski current inputs



The parameters for the Rogowski current inputs are fixed. After a changing the device may not work correctly.

42208	IN_CURRENT	REAL	0	3000.0	(In CB-Manager fixed to 3000 A)
42210			1	10.0	(In CB-Manager fixed to 10 A)
42214	IN_CURR_MAX	REAL	0	10.0	(In CB-Manager fixed to 10 A)

Modificat.	Date	Vis.:	Type:	APLUS	Page:	10 / 32	Author:	22.10.10 RR
2014-018	04.06.14	RR	Description:	<b>Modbus interface</b>	No.:	W 157 695		



Modifying parameters of the measurement input configuration may also impact the remaining device programming, which is not described in this document.

By modifying the system configuration (INPUT\_SYS) e.g. measured quantities, which are used for I/Os, limit values, data logger, operating hour counters, user specific display or the Modbus image, may become invalid (no longer measurable). This way unexpected results may occur.

A modification of the transformer ratios (IN\_VOLTAGE, IN\_CURRENT) has no influence on measurement ranges already defined or measurement thresholds of limit values. The values will not be changed proportionally. If you don't modify these values it may happen, that e.g. analog outputs go to their boundaries or limit values can no longer be reached.

#### 4.5 General

Address	Name	Type	#	Default	Description
42098	DEV_DESC	CHAR[48]	0	„APLUS“	<b>Device description text</b> If the text length is <48 characters the string must be terminated by 0. No validation is performed in the device.
42122	DEV_TAG	CHAR[32]	0	„APLUS“	<b>Unique device description</b> This parameter serves to identify the respective device in a system. For device versions with Ethernet this parameter corresponds to the host description. Therefore only the following characters may be used: 'A'...'Z', 'a'...'z', '0'...'9', '_' Also no numbers or symbols can be used at the beginning. The string must be terminated by 0.

Modificat.	Date	Vis.:	Type:	APLUS	Page:	11 / 32	Author:	22.10.10 RR
2014-018	04.06.14	RR	Description:	<b>Modbus interface</b>	No.:	W 157 695		

## 5 Measurements

### 5.1 General instantaneous values

Address	Name	14	2L	3G	3U	3A	4U	4O	Type	Description
40100	U	●	●	-	-	-	-	-	REAL	System voltage
40102	U1N	-	●	-	-	-	●	●		Voltage phase L1 to N
40104	U2N	-	●	-	-	-	●	●		Voltage phase L2 to N
40106	U3N	-	-	-	-	-	●	●		Voltage phase L3 to N
40108	U12	-	-	●	●	●	●	●		Voltage phase L1 to L2
40110	U23	-	-	●	●	●	●	●		Voltage phase L2 to L3
40112	U31	-	-	●	●	●	●	●		Voltage phase L3 to L1
40114	UNE	-	-	-	-	-	●	●		Zero displacement voltage in 4-wire systems
40116	I	●	-	●	-	-	-	-	REAL	System current
40118	I1	-	●	-	●	●	●	●		Current in phase L1
40120	I2	-	●	-	●	●	●	●		Current in phase L2
40122	I3	-	-	-	●	●	●	●		Current in phase L3
40124	IN	-	●	-	-	-	●	●		Neutral current
40126	IB	●	-	●	-	-	-	-		Bimetal current in balanced load systems
40128	IB1	-	●	-	●	●	●	●		Bimetal current in phase L 1
40130	IB2	-	●	-	●	●	●	●		Bimetal current in phase L2
40132	IB3	-	-	-	●	●	●	●		Bimetal current in phase L3
40134	P	●	●	●	●	●	●	●	REAL	Active power system ( $P = P1 + P2 + P3$ )
40136	P1	-	●	-	-	-	●	●		Active power phase 1 (L1 – N)
40138	P2	-	●	-	-	-	●	●		Active power phase 2 (L2 – N)
40140	P3	-	-	-	-	-	●	●		Active power phase 3 (L3 – N)
40142	Q	●	●	●	●	●	●	●	REAL	Reactive power system ( $Q = Q1 + Q2 + Q3$ )
40144	Q1	-	●	-	-	-	●	●		Reactive power phase 1 (L1 – N)
40146	Q2	-	●	-	-	-	●	●		Reactive power phase 2 (L2 – N)
40148	Q3	-	-	-	-	-	●	●		Reactive power phase 3 (L3 – N)
40150	S	●	●	●	●	●	●	●	REAL	Apparent power system S
40152	S1	-	●	-	-	-	●	●		Apparent power phase 1 (L1 – N)
40154	S2	-	●	-	-	-	●	●		Apparent power phase 2 (L2 – N)
40156	S3	-	-	-	-	-	●	●		Apparent power phase 3 (L3 – N)
40158	F	●	●	●	●	●	●	●	REAL	System frequency
40160	PF	●	●	●	●	●	●	●	REAL	$PF = P / S$ , Power factor system PF
40162	PF1	-	●	-	-	-	●	●		Power factor phase 1 (L1 – N)
40164	PF2	-	●	-	-	-	●	●		Power factor phase 2 (L2 – N)
40166	PF3	-	-	-	-	-	●	●		Power factor phase 3 (L3 – N)
40168	QF	●	●	●	●	●	●	●	REAL	$QF = Q / S$ , Reactive power factor system
40170	QF1	-	●	-	-	-	●	●		Reactive power factor phase 1 (L1 – N)
40172	QF2	-	●	-	-	-	●	●		Reactive power factor phase 1 (L2 – N)
40174	QF3	-	-	-	-	-	●	●		Reactive power factor phase 1 (L3 – N)
40176	LF	●	●	●	●	●	●	●	REAL	$\text{sign}(Q) \cdot (1 - \text{abs}(PF))$ , Load factor system
40178	LF1	-	●	-	-	-	●	●		Load factor phase 1 (L1 – N)
40180	LF2	-	●	-	-	-	●	●		Load factor phase 2 (L2 – N)
40182	LF3	-	-	-	-	-	●	●		Load factor phase 3 (L3 – N)
40184	U_MEAN	-	●	-	●	●	●	●	REAL	Average value of voltages $(U1x+U2x+U3x)/3$
40186	I_MEAN	-	●	-	●	●	●	●		Average value of currents $(I1+I2+I3)/3$
40188	UF12	-	-	●	●	●	●	●	REAL	Phase angle voltage U1-U2
40190	UF23	-	-	●	●	●	●	●		Phase angle voltage U2-U3
40192	UF31	-	-	●	●	●	●	●		Phase angle voltage U3-U1
40194	DEV_UMAX	-	-	●	●	●	●	●	REAL	Maximum deviation from average of voltages
40196	DEV_IMAX	-	-	-	●	●	●	●		Maximum deviation from average of currents
40198	DEV_U[3]	-	-	●	●	●	●	●	REAL	Deviation from average of voltages [U1,U2,U3]
40204	DEV_I[3]	-	-	-	●	●	●	●		Deviation from average of currents [I1,I2,I3]
40210	IMS	-	-	-	●	●	●	●	REAL	Average value of currents with sign of active power P

Modificat.	Date	Vis.:	Type:	APLUS	Page:	12 / 32	Author:	22.10.10 RR
2014-018	04.06.14	RR	Description:	<b>Modbus interface</b>	No.:	W 157 695		

## 5.2 System analysis

### 5.2.1 Instantaneous values of harmonic analysis

Address	Name	14	2L	3G	3U	3A	4U	4O	Type	Description
40236	THD_U1x	U	U1N	U12	U12	U12	U1N	U1N	REAL	Total Harmonic Distortion [%]
40238	THD_U2x	-	U2N	U23	U23	U23	U2N	U2N		Total Harmonic Distortion [%]
40240	THD_U3x	-	-	U31	U31	U31	U3N	U3N		Total Harmonic Distortion [%]
40242	TDD_I1	I	I1	I	I1	I1	I1	I1	REAL	Total Demand Distortion [%]
40244	TDD_I2	-	I2	-	I2	I2	I2	I2		Total Demand Distortion [%]
40246	TDD_I3	-	-	-	I3	I3	I3	I3		Total Demand Distortion [%]

► THD\_U: Harmonic content related to the fundamental of the RMS value of the voltage

► TDD\_I: Harmonic content related to the **rated value** of the current

Address	Name	14	2L	3G	3U	3A	4U	4O	Type	Description
40250	H2_U1X ..... H31_U1X	U	U1N	U12	U12	U12	U1N	U1N	UINT16	Content of 2 <sup>nd</sup> harmonic [%] ..... Content of 31 <sup>st</sup> harmonic [%]
40280	H2_U2X ..... H31_U2X	-	U2N	U23	U23	U23	U2N	U2N		UINT16
40310	H2_U3X ..... H31_U3X	-	-	U31	U31	U31	U3N	U3N	UINT16	
40340	H2_I1X ..... H31_I1X	I	I1	I	I1	I1	I1	I1		UINT16
40370	H2_I2X ..... H31_I2X	-	I2	-	I2	I2	I2	I2	UINT16	
40400	H2_I3X ..... H31_I3X	-	-	-	I3	I3	I3	I3		UINT16
40430	H32_U1X ..... H63_U1X	U	U1N	U12	U12	U12	U1N	U1N	UINT16	
40462	H32_U2X ..... H63_U2X	-	U2N	U23	U23	U23	U2N	U2N		UINT16
40494	H32_U3X ..... H63_U3X	-	-	U31	U31	U31	U3N	U3N	UINT16	
40526	H32_I1X ..... H63_I1X	I	I1	I	I1	I1	I1	I1		UINT16
40558	H32_I2X ..... H63_I2X	-	I2	-	I2	I2	I2	I2	UINT16	
40590	H32_I3X ..... H63_I3X	-	-	-	I3	I3	I3	I3		UINT16

► Hi\_Uxy: Harmonic content of the voltage related to the fundamental 100 %

► Hi\_Ixy: Harmonic content of the current related to the rated current

The individual harmonics are implemented as unsigned 16-Bit numbers (1 register per value).

Range of values: 0 corresponds to 0.0%, 1000 corresponds to 100.0 %.

Modificat.	Date Vis.:	Type:	APLUS	Page: 13 / 32	Author: 22.10.10 RR
2014-018	04.06.14 RR	Description:	<b>Modbus interface</b>	No.:	W 157 695

### 5.2.2 Instantaneous values of imbalance analysis

Address	Name	14	2L	3G	3U	3A	4U	4O	Type	Description
40216	UR1	-	-	•	•	•	•	-	REAL	Voltage [V]: Positive sequence
40218	UR2	-	-	•	•	•	•	-		Voltage [V]: Negative sequence
40220	U0	-	-	-	-	-	•	-		Voltage [V]: Zero sequence
40222	IR1	-	-	-	•	-	•	•	REAL	Current [A]: Positive sequence
40224	IR2	-	-	-	•	-	•	•		Current [A]: Negative sequence
40226	I0	-	-	-	-	-	•	•		Current [A]: Zero sequence
40228	UNB_UR2_UR1	-	-	•	•	•	•	-	REAL	Imbalance factor voltage: UR2/UR1 [%]
40230	UNB_IR2_IR1	-	-	-	•	-	•	•		Imbalance factor current: IR2/IR1 [%]
40232	UNB_U0_UR1	-	-	-	-	-	•	-	REAL	Imbalance factor voltage: U0/UR1 [%]
40234	UNB_I0_IR1	-	-	-	-	-	•	•		Imbalance factor current: I0/IR1 [%]

### 5.2.3 Instantaneous values of reactive power analysis

Address	Name	14	2L	3G	3U	3A	4U	4O	Type	Description
41660	D	•	•	•	•	•	•	•	REAL	Distortion reactive power, system
41662	D1	-	•	-	-	-	•	•		Distortion reactive power, phase L1
41664	D2	-	•	-	-	-	•	•		Distortion reactive power, phase L2
41666	D3	-	-	-	-	-	•	•		Distortion reactive power, phase L3
41668	QG	•	•	•	•	•	•	•	REAL	Reactive power of fundamental, system
41670	QG1	-	•	-	-	-	•	•		Reactive power of fundamental, phase L1
41672	QG2	-	•	-	-	-	•	•		Reactive power of fundamental, phase L2
41674	QG3	-	-	-	-	-	•	•		Reactive power of fundamental, phase L3
41676	PFG	•	•	•	•	•	•	•	REAL	cos( $\varphi$ ) of fundamental, system
41678	PFG1	-	•	-	-	-	•	•		cos( $\varphi$ ) of fundamental, phase L1
41680	PFG2	-	•	-	-	-	•	•		cos( $\varphi$ ) of fundamental, phase L2
41682	PFG3	-	-	-	-	-	•	•		cos( $\varphi$ ) of fundamental, phase L3
41676	PFG	•	•	•	•	•	•	•	REAL	tan( $\varphi$ ) of fundamental, system
41678	PFG1	-	•	-	-	-	•	•		tan( $\varphi$ ) of fundamental, phase L1
41680	PFG2	-	•	-	-	-	•	•		tan( $\varphi$ ) of fundamental, phase L2
41682	PFG3	-	-	-	-	-	•	•		tan( $\varphi$ ) of fundamental, phase L3

Modificat.	Date	Vis.:	Type:	APLUS	Page:	14 / 32	Author:	22.10.10 RR
2014-018	04.06.14	RR	Description:	<b>Modbus interface</b>	No.:	W 157 695		

### 5.3 Minimum / maximum values of system quantities

Time [TIME]	Value [REAL]	Reset [COIL]	Name	14	2L	3G	3U	3A	4U	4O	Description
40630	40718	500	U_MAX	•	•	-	-	-	-	-	Maximum value of U
40632	40720	501	U1N_MAX	-	•	-	-	-	•	•	Maximum value of U1N
40634	40722	502	U2N_MAX	-	•	-	-	-	•	•	Maximum value of U2N
40636	40724	503	U3N_MAX	-	-	-	-	-	•	•	Maximum value of U3N
40638	40726	504	U12_MAX	-	-	•	•	•	•	•	Maximum value of U12
40640	40728	505	U23_MAX	-	-	•	•	•	•	•	Maximum value of U23
40642	40730	506	U31_MAX	-	-	•	•	•	•	•	Maximum value of U31
40644	40732	507	UNE_MAX	-	-	-	-	-	•	•	Maximum value of UNE
40646	40734	508	I_MAX	•	-	•	-	-	-	-	Maximum value of I
40648	40736	509	I1_MAX	-	•	-	•	•	•	•	Maximum value of I1
40650	40738	510	I2_MAX	-	-	-	•	•	•	•	Maximum value of I2
40652	40740	511	I3_MAX	-	-	-	•	•	•	•	Maximum value of I3
40654	40742	512	IN_MAX	-	•	-	-	-	•	•	Maximum value of IN
40656	40744	513	IB_MAX	•	-	•	-	-	-	-	Maximum value of IB
40658	40746	514	IB1_MAX	-	•	-	•	•	•	•	Maximum value of IB1
40660	40748	515	IB2_MAX	-	•	-	•	•	•	•	Maximum value of IB2
40662	40750	516	IB3_MAX	-	-	-	•	•	•	•	Maximum value of IB3
40664	40752	517	P_MAX	•	•	•	•	•	•	•	Maximum value of P
40666	40754	518	P1_MAX	-	•	-	-	-	•	•	Maximum value of P1
40668	40756	519	P2_MAX	-	•	-	-	-	•	•	Maximum value of P2
40670	40758	520	P3_MAX	-	-	-	-	-	•	•	Maximum value of P3
40672	40760	521	Q_MAX	•	•	•	•	•	•	•	Maximum value of Q
40674	40762	522	Q1_MAX	-	•	-	-	-	•	•	Maximum value of Q1
40676	40764	523	Q2_MAX	-	•	-	-	-	•	•	Maximum value of Q2
40678	40766	524	Q3_MAX	-	-	-	-	-	•	•	Maximum value of Q3
40680	40768	525	S_MAX	•	•	•	•	•	•	•	Maximum value of S
40682	40770	526	S1_MAX	-	•	-	-	-	•	•	Maximum value of S1
40684	40772	527	S2_MAX	-	•	-	-	-	•	•	Maximum value of S2
40686	40774	528	S3_MAX	-	-	-	-	-	•	•	Maximum value of S3
40688	40776	529	F_MAX	•	•	•	•	•	•	•	Maximum value of F
40690	40778	530	DEV_UMAX_MAX	-	-	•	•	•	•	•	Maximum value of DEV_UMAX
40692	40780	531	DEV_IMAX_MAX	-	-	-	•	•	•	•	Maximum value of DEV_IMAX
40694	40782	532	U_MIN	•	•	-	-	-	-	-	Minimum value of U
40696	40784	533	U1N_MIN	-	•	-	-	-	•	•	Minimum value of U1N
40698	40786	534	U2N_MIN	-	•	-	-	-	•	•	Minimum value of U2N
40700	40788	535	U3N_MIN	-	-	-	-	-	•	•	Minimum value of U3N
40702	40790	536	U12_MIN	-	-	•	•	•	•	•	Minimum value of U12
40704	40792	537	U23_MIN	-	-	•	•	•	•	•	Minimum value of U23
40706	40794	538	U31_MIN	-	-	•	•	•	•	•	Minimum value of U31
40708	40796	539	PF_MIN_IN_L	•	•	•	•	•	•	•	min. power factor incoming / inductive
40710	40798	540	PF_MIN_IN_C	•	•	•	•	•	•	•	min. power factor incoming / capacitive
40712	40800	541	PF_MIN_OUT_L	•	•	•	•	•	•	•	min. power factor outgoing / inductive
40714	40802	542	PF_MIN_OUT_C	•	•	•	•	•	•	•	min. power factor outgoing / capacitive
40716	40804	543	F_MIN	•	•	•	•	•	•	•	Minimum value of F

- ▶ by setting Coils 500...543 (Reset) the appropriate maximum resp. minimum value with timestamp will be reset.
- ▶ when delivered all timestamps are set to "1.1.1970". This time entry is as well a sign that the associated measurement is invalid.

Modificat.	Date	Vis.:	Type:	<i>APLUS</i>	Page:	15 / 32	Author:	22.10.10 RR
2014-018	04.06.14	RR	Description:	<b>Modbus interface</b>	No.:	W 157 695		

## 5.4 Minimum / maximum values of system analysis

### 5.4.1 Maximum values of harmonic analysis

Time [TIME]	Value [REAL]	Reset [COIL]	Name	14	2L	3G	3U	3A	4U	4O	Description
40818	40838	674	THD_U1X_MAX	U	U1N	U12	U12	U12	U1N	U1N	max. THD value phase 1
40820	40840	675	THD_U2X_MAX	-	U2N	U23	U23	U23	U2N	U2N	max. THD value phase 2
40822	40842	676	THD_U3X_MAX	-	-	U31	U31	U31	U3N	U3N	max. THD value phase 3
40824	40844	677	TDD_I1X_MAX	I	I1	I	I1	I1	I1	I1	max. TDD value phase 1
40826	40846	678	TDD_I2X_MAX	-	I2	-	I2	I2	I2	I2	max. TDD value phase 2
40828	40848	679	TDD_I3X_MAX	-	-	-	I3	I3	I3	I3	max. TDD value phase 3

Time [TIME]	Value [REAL]	Reset [COIL]	Name	14	2L	3G	3U	3A	4U	4O	Description
40818	40850	674	H2_U1X_MAX ..... H31_U1X_MAX	U	U1N	U12	U12	U12	U1N	U1N	max. content of 2 <sup>nd</sup> harmonic [%] ..... max. content of 31 <sup>st</sup> harmonic [%]
40820	40880	675	H2_U2X_MAX ..... H31_U2X_MAX	-	U2N	U23	U23	U23	U2N	U2N	max. content of 2 <sup>nd</sup> harmonic [%] ..... max. content of 31 <sup>st</sup> harmonic [%]
40822	40910	676	H2_U3X_MAX ..... H31_U3X_MAX	-	-	U31	U31	U31	U3N	U3N	max. content of 2 <sup>nd</sup> harmonic [%] ..... max. content of 31 <sup>st</sup> harmonic [%]
40824	40940	677	H2_I1X_MAX ..... H31_I1X_MAX	I	I1	I	I1	I1	I1	I1	max. content of 2 <sup>nd</sup> harmonic [%] ..... max. content of 31 <sup>st</sup> harmonic [%]
40826	40970	678	H2_I2X_MAX ..... H31_I2X_MAX	-	I2	-	I2	I2	I2	I2	max. content of 2 <sup>nd</sup> harmonic [%] ..... max. content of 31 <sup>st</sup> harmonic [%]
40828	41000	679	H2_I3X_MAX ..... H31_I3X_MAX	-	-	-	I3	I3	I3	I3	max. content of 2 <sup>nd</sup> harmonic [%] ..... max. content of 31 <sup>st</sup> harmonic [%]
40818	41030	674	H32_U1X_MAX ..... H63_U1X_MAX	U	U1N	U12	U12	U12	U1N	U1N	max. content of 32 <sup>nd</sup> harmonic [%] ..... max. content of 63 <sup>rd</sup> harmonic [%]
40820	41062	675	H32_U2X_MAX ..... H63_U2X_MAX	-	U2N	U23	U23	U23	U2N	U2N	max. content of 32 <sup>nd</sup> harmonic [%] ..... max. content of 63 <sup>rd</sup> harmonic [%]
40822	41094	676	H32_U3X_MAX ..... H63_U3X_MAX	-	-	U31	U31	U31	U3N	U3N	max. content of 32 <sup>nd</sup> harmonic [%] ..... max. content of 63 <sup>rd</sup> harmonic [%]
40824	41126	677	H32_I1X_MAX ..... H63_I1X_MAX	I	I1	I	I1	I1	I1	I1	max. content of 32 <sup>nd</sup> harmonic [%] ..... max. content of 63 <sup>rd</sup> harmonic [%]
40826	41158	678	H32_I2X_MAX ..... H63_I2X_MAX	-	I2	-	I2	I2	I2	I2	max. content of 32 <sup>nd</sup> harmonic [%] ..... max. content of 63 <sup>rd</sup> harmonic [%]
40828	41190	679	H32_I3X_MAX ..... H63_I3X_MAX	-	-	-	I3	I3	I3	I3	max. content of 32 <sup>nd</sup> harmonic [%] ..... max. content of 63 <sup>rd</sup> harmonic [%]

► the maximum values of the harmonic analysis arise from monitoring the maximum values of THD resp. TDD. The maximum values of the individual harmonics are not monitored separately, but stored when a maximum value of THD or TDD is recognized. The image of the maximum harmonics therefore always corresponds to the associated THD resp. TDD.

► by setting Coils 674...679 (reset) the appropriate maximum values of THD / TDD, the individual harmonics and the timestamp will be reset at the same time.

► when delivered all timestamps are set to "1.1.1970". This time entry is as well a sign that all associated measurements are invalid.

The individual harmonics are implemented as unsigned 16-Bit numbers (1 register per value). Range of values: 0 corresponds to 0.0%, 1000 corresponds to 100.0 %.

Modificat.	Date	Vis.:	Type:	APLUS	Page:	16 / 32	Author:	22.10.10 RR
2014-018	04.06.14	RR	Description:	<b>Modbus interface</b>	No.:	W 157 695		



#### 5.4.2 Maximum values of imbalance analysis

Time [TIME]	Value [REAL]	Reset [COIL]	Name	14	2L	3G	3U	3A	4U	4O	Description
40810	40830	670	UNB_UR2_UR1_MAX	-	-	•	•	•	•	-	max. imbalance UR2/UR1
40812	40832	671	UNB_IR2_IR1_MAX	-	-	-	-	-	•	•	max. imbalance IR2/IR1
40814	40834	672	UNB_U0_UR1_MAX	-	-	-	•	-	•	-	max. imbalance U0/UR1
40816	40836	673	UNB_I0_IR1_MAX	-	-	-	-	-	•	•	max. imbalance I0/IR1

► by setting Coils 670...673 (reset) the associated maximum value with timestamp will be reset.

#### 5.4.3 Maximum values of reactive power analysis

Time [TIME]	Value [REAL]	Reset [COIL]	Name	14	2L	3G	3U	3A	4U	4O	Description
43930	43954	700	D_MAX	-	-	•	•	•	•	-	max. distortion reactive power, system
43932	43956	701	D1_MAX	-	-	-	-	-	•	•	max. distortion reactive power, phase L1
43934	43958	702	D2_MAX	-	-	-	•	-	•	-	max. distortion reactive power, phase L2
43936	43960	703	D3_MAX	-	-	-	-	-	•	•	max. distortion reactive power, phase L3
43938	43962	704	QG_MAX	-	-	•	•	•	•	-	max. reactive power fundamental, system
43940	43964	705	QG1_MAX	-	-	-	-	-	•	•	max. reactive power fundamental, L1
43942	43966	706	QG2_MAX	-	-	-	•	-	•	-	max. reactive power fundamental, L2
43944	43968	707	QG3_MAX	-	-	-	-	-	•	•	max. reactive power fundamental, L3
43946	43970	708	PFG_MIN_IN_L	-	-	•	•	•	•	-	min. $\cos(\varphi)$ incoming, inductive (*)
43948	43972	709	PFG_MIN_IN_C	-	-	-	-	-	•	•	min. $\cos(\varphi)$ incoming, capacitive (*)
43950	43974	710	PFG_MIN_OUT_L	-	-	-	•	-	•	-	min. $\cos(\varphi)$ outgoing, inductive (*)
43952	43976	711	PFG_MIN_OUT_C	-	-	-	-	-	•	•	min. $\cos(\varphi)$ outgoing, capacitive (*)

(\*) min.  $\cos(\varphi)$  of the system fundamental in all 4 quadrants

- by setting Coils 700...707 (reset) the associated maximum value with timestamp will be reset.
- by setting Coils 708...711 (reset) the associated minimum value with timestamp will be reset.
- when delivered all timestamps are set to "1.1.1970". This time entry is as well a sign that all associated measurements are invalid.

Modificat.	Date	Vis.:	Type:	APLUS	Page:	17 / 32	Author:	22.10.10 RR
2014-018	04.06.14	RR	Description:	<b>Modbus interface</b>	No.:	W 157 695		

## 5.5 Mean-values, trends, minimum / maximum values

### 5.5.1 Mean values of power (standard quantities)

Name	Trend	Mean-value	Maximum			Minimum			Description
	[REAL]	Last ..... - 4 [REAL]	Time [TIME]	Value [REAL]	Reset [COIL]	Time [TIME]	Value [REAL]	Reset [COIL]	
AVG_PIN	41306	41236... 41244	41348	41320	1030	41362	41334	1037	Mean-value P, incoming
AVG_POUT	41308	41246...41254	41350	41322	1031	41364	41336	1038	Mean-value P, outgoing
AVG_QIND	41310	41256...41264	41352	41324	1032	41366	41338	1039	Mean-value Q, inductive
AVG_QCAP	41312	41266...41274	41354	41326	1033	41368	41340	1040	Mean-value Q, capacitive
AVG_QIN	41314	41276...41284	41356	41328	1034	41370	41342	1041	Mean-value Q, incoming
AVG_QOUT	41316	41286...41294	41358	41330	1035	41372	41344	1042	Mean-value Q, outgoing
AVG_S	41318	41296...41304	41360	41332	1036	41374	41346	1043	Mean-value S

- ▶ by setting Coils 1030...1036 (reset) the associated maximum value with timestamp will be reset.
- ▶ by setting Coils 1037...1043 (reset) the associated minimum value with timestamp will be reset.
- ▶ when delivered all timestamps are set to "1.1.1970". This time entry is as well a sign that the associated measurement is invalid.
- ▶ for each of the standard quantities the mean-value for the last interval and the 4 previous values are provided.

### 5.5.2 Free configurable mean-value quantities

Name	Trend	Mean-value	Maximum			Minimum			Description
	[REAL]	Last ..... - 4 [REAL]	Time [TIME]	Value [REAL]	Reset [COIL]	Time [TIME]	Value [REAL]	Reset [COIL]	
AVG_1	41400	41376	41472	41424	1044	41496	41448	1056	Config. mean-value 1
AVG_2	41402	41378	41474	41426	1045	41498	41450	1057	Config. mean-value 2
AVG_3	41404	41380	41476	41428	1046	41500	41452	1058	Config. mean-value 3
AVG_4	41406	41382	41478	41430	1047	41502	41454	1059	Config. mean-value 4
AVG_5	41408	41384	41480	41432	1048	41504	41456	1060	Config. mean-value 5
AVG_6	41410	41386	41482	41434	1049	41506	41458	1061	Config. mean-value 6
AVG_7	41412	41388	41484	41436	1050	41508	41460	1062	Config. mean-value 7
AVG_8	41414	41390	41486	41438	1051	41510	41462	1063	Config. mean-value 8
AVG_9	41416	41392	41488	41440	1052	41512	41464	1064	Config. mean-value 9
AVG_10	41418	41394	41490	41442	1053	41514	41466	1065	Config. mean-value 10
AVG_11	41420	41396	41492	41444	1054	41516	41468	1066	Config. mean-value 11
AVG_12	41422	41398	41494	41446	1055	41518	41470	1067	Config. mean-value 12

- ▶ by setting Coils 1044...1055 (reset) the associated maximum value with timestamp will be reset.
- ▶ by setting Coils 1056...1067 (reset) the associated minimum value with timestamp will be reset.
- ▶ when delivered all timestamps are set to "1.1.1970". This time entry is as well a sign that the associated measurement is invalid.

Modificat.	Date	Vis.:	Type:	APLUS	Page:	18 / 32	Author:	22.10.10 RR
2014-018	04.06.14	RR	Description:	<b>Modbus interface</b>	No.:	W 157 695		

## 5.6 Instantaneous values of analog outputs

Address	Name	Type	Default	Description
41520	AOUT1	REAL	0.0	Present value of analog output 1 [mA]
41522	AOUT2		0.0	Present value of analog output 2 [mA]
41524	AOUT3		0.0	Present value of analog output 3 [mA]
41526	AOUT4		0.0	Present value of analog output 4 [mA]

## 5.7 Present state of limit values

Address	Name	Type	Default	Description
41530	LIMIT_STATE	UINT16	0	Bit 0: State of limit value 1 (0=OFF, 1=ON) Bit 1: State of limit value 2 (0=OFF, 1=ON) Bit 2: State of limit value 3 (0=OFF, 1=ON) Bit 3: State of limit value 4 (0=OFF, 1=ON) Bit 4: State of limit value 5 (0=OFF, 1=ON) Bit 5: State of limit value 6 (0=OFF, 1=ON) Bit 6: State of limit value 7 (0=OFF, 1=ON) Bit 7: State of limit value 8 (0=OFF, 1=ON) Bit 8: State of limit value 9 (0=OFF, 1=ON) Bit 9: State of limit value 10 (0=OFF, 1=ON) Bit 10: State of limit value 11 (0=OFF, 1=ON) Bit 11: State of limit value 12 (0=OFF, 1=ON) Bit 12: State of limit value 13 (0=OFF, 1=ON) Bit 13: State of limit value 14 (0=OFF, 1=ON) Bit 14: State of limit value 15 (0=OFF, 1=ON) Bit 15: State of limit value 16 (0=OFF, 1=ON)

## 5.8 Free scalable 16-Bit Modbus image

In this memory area all measurements are provided, which have been arranged in the free Modbus image (16 Bit). Therefore sequence and content are user specified.

Address	Name	Type	Default	Description
41800	REG_VALUE	INT16[20]	0	Scaled measurements in Integer format Measured quantities and scaling factors as defined by user

## 5.9 Free selectable Modbus image

In this memory area all measurements are provided, which have been arranged in the free Modbus image (Float). Therefore sequence and content are user specified.

Address	Name	Type	Default	Description
41840	REAL_VALUE	REAL[60]	0.0	Measurements in Float format Measured quantities as defined by user

Modificat.	Date Vis.:	Type:	APLUS	Page: 19 / 32	Author: 22.10.10 RR
2014-018	04.06.14 RR	Description:	<b>Modbus interface</b>	No.: W 157 695	

## 5.10 Present state of logic functions

For an improved analysis not only the input and output signals may be read, but also interim states of the evaluation.

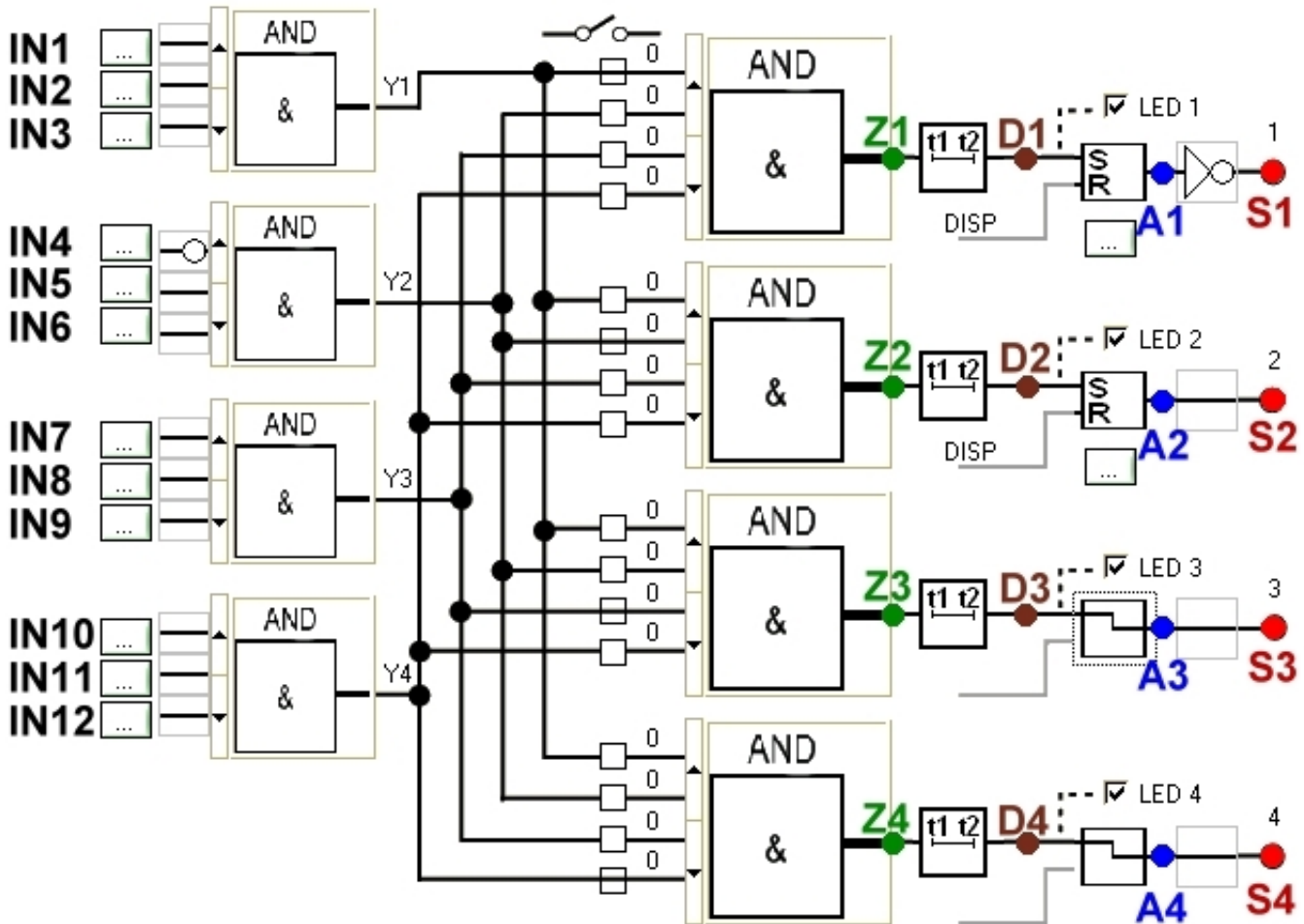

Address	Name	Type	Default	Description
43918	LOGIC_OUT	UINT16	0	<b>Logic output Z1...Z4</b> (Bit 0...Bit 3) These outputs represent the undelayed signals of the evaluation of the logical equations including all involved inputs.
43919	LOGIC_DELAYED	UINT16	0	<b>Logic output delayed D1...D4</b> (Bit 0...Bit 3) These outputs correspond to Z1...Z4, delayed by the defined switch-in resp. dropout delay. These states are displayed by means of the LED's, if configured accordingly. For devices with TFT display these states are visualized via alarm list.
43920	LOGIC_ALARM	UINT16	0	<b>Alarm states A1...A4</b> (Bit 0...Bit 3) The alarm states correspond to the output signals S1...S4, if these are not inverted. If the output signals are not resettable these signals are the same as D1...D4.
43921	LOGIC_STAT	UINT16	0	<b>Output signals S1...S4</b> (Bit 0...Bit 3) The output signals S1...S4 correspond to A1...A4, if no inversion of the outputs is performed. Based on the output signals the alarm state texts are assigned. Configured subsequent actions, such as the switching of a relay, take over the states of S1...S4.
43922	LOGIC_IN	UINT16	0	<b>States of logic inputs IN1...IN12</b> (Bit 0...11)
43923	LOGIC_BUSIN	UINT16	0	<b>States of bus presettings IN1...IN12</b> (Bit 0...11) The states of the logic inputs may also be predefined via bus. To do so this register is not only readable but writable as well.

Modificat.	Date	Vis.:	Type:	APLUS	Page:	20 / 32	Author:	22.10.10 RR
2014-018	04.06.14	RR	Description:	<b>Modbus interface</b>	No.:	W 157 695		

## Acknowledgment and alarm reset

- **Acknowledgment:** Each alarm visualized via LED have to be acknowledged, no matter if it is still active (fast flashing) or has dropped-out already (slow flashing). By acknowledging the alarm display the flashing of the LED's stops, but a reset of the alarm is performed only if it is configured accordingly.



Acknowledgment is not required if "**acknowledgement of alarm LEDs required**" in the logic module configuration is not selected.

Acknowledgment is not supported for device versions with TFT display.

- **Alarm reset:** The alarm handling may be configured that an alarm reset of the subsequent operation (e.g. the switching of a relay) is withdrawn. This way an alarm remains stored until a reset is performed, even if the alarm situation no longer exists.

Possible sources for a reset are:

- the display (at the same time as the alarm display acknowledgment, for versions with LED display only)
- a digital input
- another logical state of the logic module
- a command via the **bus interface**

Address	Name	Type	Description
200	LOGIC_RESET1	COIL	Reset of alarm 1 (Logic function 1)
201	LOGIC_RESET2	COIL	Reset of alarm 2 (Logic function 2)
202	LOGIC_RESET3	COIL	Reset of alarm 3 (Logic function 3)
203	LOGIC_RESET4	COIL	Reset of alarm 4 (Logic function 4)

### Examples of signal flows (for logic function 1)

Configuration	Value	Signal flow
Alarm reset Switch-in delay Dropout delay Output inversion	inactive 3 s 3 s no	
Alarm reset Switch-in delay Dropout delay Output inversion	inactive 3 s 3 s yes	

Configuration	Value	Signal flow
Alarm reset Switch-in delay Dropout delay Output inversion	active 0 s 0 s no	<p><b>Reset is performed when the alarm situation no longer exists.</b></p>
Alarm reset Switch-in delay Dropout delay Output inversion	active 0 s 0 s no	<p><b>Reset is performed when the alarm situation still exists.</b></p>
Alarm reset Switch-in delay Dropout delay Output inversion	activated 1 s 1 s yes	<p><b>Reset is performed when the alarm situation still exists.</b></p>

### 5.11 Present states of digital I/O's

Address	Name	Type	Description	available
1	IO1	COIL	Present state I/O 1 (Relay)	always
2	IO2	COIL	Present state I/O 2 (Digital input 24V)	always
3	IO3	COIL	Present state I/O 3 (Digital input 24V)	always
4	IO4	COIL	Present state I/O 4 (Relay)	EXT 1 / 2
5	IO5	COIL	Present state I/O 5 (Relay)	EXT 1 / 2
6	IO6	COIL	Present state I/O 6 (Digital I/O 24V)	EXT 1 / 2
7	IO7	COIL	Present state I/O 7 (Digital I/O 24V)	EXT 1 / 2
8	IO8	COIL	Present state I/O 8 (Digital I/O 24V)	EXT 2
9	IO9	COIL	Present state I/O 9 (Digital I/O 24V)	EXT 2
10	IO10	COIL	Present state I/O 10 (Digital I/O 24V)	EXT 2
11	IO11	COIL	Present state I/O 11 (Digital I/O 24V)	EXT 2

**EXT 1** Devices with I/O extension 1: 2 relays, 2 digital I/O's, 4 analog outputs

**EXT 2** Devices with I/O extension 2: 2 relays, 6 digit I/O's

Modificat.	Date	Vis.:	Type:	<i>APLUS</i>	Page: 23 / 32	Author: 22.10.10 RR
2014-018	04.06.14	RR	Description:	<b>Modbus interface</b>	No.: W 157 695	

## 6 Energy meters

### 6.1 General

Meters are generally provided as 32-Bit integer numbers without sign, because only this way it's assured that no resolution gets lost. The values have 8 digits maximum and correspond to the meter contents shown on the display. In case of a carry to the 9<sup>th</sup> digit a reset of the meter content to zero is performed.

To convert the 8-digit numbers to the physical, primary side meter content they must be scaled. This is done using a **unit factor**, which implies the position of the decimal point and the basic unit of the meter quantity. If the configuration of the device is not modified this factor remains unchanged and therefore have to be read only once.

$$\text{Physical meter value} = \text{Meter content} * 10^X \text{ [Wh or varh]}$$

**Example:** P<sub>incoming HT</sub> = 12056; CNTR\_EXP = 4

$$\text{Meter content: } 12056 * 10^4 \text{ [Wh]} = 12056 * 10^6 * 10^{-2} \text{ [Wh]} = \mathbf{120.56 \text{ [MWh]}}$$

↑
↑  
[MWh]
2 post decimal positions

### 6.2 Meter contents of standard quantities

Value [UINT32]	Reset [COIL]	Name	14	2L	3G	3U	3A	4U	4O	Description
41580	1460	PIN_HT	•	•	•	•	•	•	•	Active energy incoming, High tariff
41582	1461	POUT_HT	•	•	•	•	•	•	•	Active energy outgoing, High tariff
41584	1462	QIND_HT	•	•	•	•	•	•	•	Reactive energy inductive, High tariff
41586	1463	QCAP_HT	•	•	•	•	•	•	•	Reactive energy capacitive, High tariff
41588	1464	QIN_HT	•	•	•	•	•	•	•	Reactive energy incoming, High tariff
41590	1465	QOUT_HT	•	•	•	•	•	•	•	Reactive energy outgoing, High tariff
41592	1466	PIN_LT	•	•	•	•	•	•	•	Active energy incoming, Low tariff
41594	1467	POUT_LT	•	•	•	•	•	•	•	Active energy outgoing, Low tariff
41596	1468	QIND_LT	•	•	•	•	•	•	•	Reactive energy inductive, Low tariff
41598	1469	QCAP_LT	•	•	•	•	•	•	•	Reactive energy capacitive, Low tariff
41600	1470	QIN_LT	•	•	•	•	•	•	•	Reactive energy incoming, Low tariff
41602	1471	QOUT_LT	•	•	•	•	•	•	•	Reactive energy outgoing, Low tariff
41604	1472	P1IN_HT		•		•	•	•	•	Active energy incoming L1, High tariff
41606	1473	P2IN_HT		•		•	•	•	•	Active energy incoming L2, High tariff
41608	1474	P3IN_HT				•	•	•	•	Active energy incoming L3, High tariff
41610	1475	Q1IN_HT		•		•	•	•	•	Reactive energy incoming L1, High tariff
41612	1476	Q2IN_HT		•		•	•	•	•	Reactive energy incoming L2, High tariff
41614	1477	Q3IN_HT				•	•	•	•	Reactive energy incoming L3, High tariff
41616	1478	P1IN_LT		•		•	•	•	•	Active energy incoming L1, Low tariff
41618	1479	P2IN_LT		•		•	•	•	•	Active energy incoming L2, Low tariff
41620	1480	P3IN_LT				•	•	•	•	Active energy incoming L3, Low tariff
41622	1481	Q1IN_LT		•		•	•	•	•	Reactive energy incoming L1, Low tariff
41624	1482	Q2IN_LT		•		•	•	•	•	Reactive energy incoming L2, Low tariff
41626	1483	Q3IN_LT				•	•	•	•	Reactive energy incoming L3, Low tariff

► by setting Coils 1460...1483 (reset) the associated meter content with timestamp will be reset.

Value	Type	Name	Description
41628	UINT16	CNTR_EXP	Unit factor for all standard meters (read only)

Modificat.	Date	Vis.:	Type:	APLUS	Page:	24 / 32	Author:	22.10.10 RR
2014-018	04.06.14	RR	Description:	<b>Modbus interface</b>	No.:	W 157 695		



### 6.3 Meter contents of I/O meters

Wert [UINT32]	Reset [COIL]	Name	Description
41540	1410	CNTR_IO2_HT	Meter I/O 2 high tariff
41542	1411	CNTR_IO6_HT	Meter I/O 6 high tariff
41544	1412	CNTR_IO7_HT	Meter I/O 7 high tariff
41546	1413	CNTR_IO8_HT	Meter I/O 8 high tariff
41548	1414	CNTR_IO9_HT	Meter I/O 9 high tariff
41550	1415	CNTR_IO10_HT	Meter I/O 10 high tariff
41552	1416	CNTR_IO11_HT	Meter I/O 11 high tariff
41554	1417	CNTR_IO2_LT	Meter I/O 2 low tariff
41556	1418	CNTR_IO6_LT	Meter I/O 6 low tariff
41558	1419	CNTR_IO7_LT	Meter I/O 7 low tariff
41560	1420	CNTR_IO8_LT	Meter I/O 8 low tariff
41562	1421	CNTR_IO9_LT	Meter I/O 9 low tariff
41564	1422	CNTR_IO10_LT	Meter I/O 10 low tariff
41566	1423	CNTR_IO11_LT	Meter I/O 11 low tariff

► by setting Coils 1410...1423 (reset) the associated meter content with timestamp will be reset.

Value	Type	Name	Description
41568	UINT16	CNTR_EXP_IO2	Unit factor for high and low tariff meter of I/O 2
41569		CNTR_EXP_IO6	Unit factor for high and low tariff meter of I/O 6
41570		CNTR_EXP_IO7	Unit factor for high and low tariff meter of I/O 7
41571		CNTR_EXP_IO8	Unit factor for high and low tariff meter of I/O 8
41572		CNTR_EXP_IO9	Unit factor for high and low tariff meter of I/O 9
41573		CNTR_EXP_IO10	Unit factor for high and low tariff meter of I/O 10
41574		CNTR_EXP_IO11	Unit factor for high and low tariff meter of I/O 11

### 6.4 Present tariff of meters

The device supports two tariffs, high and low tariff. The same tariff is used for both, standard meters and I/O meters.

The tariff may be changed via interface, by overwriting the existing tariff situation. To rule out possible manipulations this operation may be locked during device configuration by means of the security system. If tariff switching is performed via a digital input, overwriting the tariff situation has no effect.

Value	Type	Name	Description
41629	UNIT16	CNTR_TARIFF	<b>Tariff situation</b> (readable and writable) 0: high tariff 1: low tariff

Modificat.	Date	Vis.:	Type:	APLUS	Page: 25 / 32	Author: 22.10.10 RR
2014-018	04.06.14	RR	Description:	<b>Modbus interface</b>	No.:	W 157 695

## 7 Operating hour counters

The operating hour counters have a resolution of [s]. This allow to measure operating times up to 136 years, whereby an overflow is excluded.

The operating hour counter *APLUS* starts to count as soon as the power supply is applied to the device. The meter is designed as endless counter and can't be reset.

The resettable operating hour counters 1...3 count, if the condition configured for them is fulfilled. Possible conditions are:

- always (power supply switched on)
- never (counter inactive)
- if a measured value goes above or below a certain limit value
- fulfilled logic function

Value [UINT32]	Reset [COIL]	Name	Description
41650	-	OPR_CNTR	Operating hour counter <i>APLUS</i> [s]
41652	20	OPR_CNTR1	Resettable operating hour counter 1 [s]
41654	21	OPR_CNTR2	Resettable operating hour counter 2 [s]
41656	22	OPR_CNTR3	Resettable operating hour counter 3 [s]

► by setting Coils 20...22 (reset) the associated operating hour counter with timestamp will be reset.

Modificat.	Date	Vis.:	Type: <i>APLUS</i>	Page: 26 / 32	Author: 22.10.10 RR
2014-018	04.06.14	RR	Description: <b>Modbus interface</b>	No.: W 157 695	

## 8 Modbus interface



To assure that each device may be accessed, independent of the used communication hardware, the response time has a factory setting of **100 ms**. A faster response time may be set via the register COM\_OPTIONS.

The response time is the delay a device waits until it sends an answer to a request. In accordance with the Modbus standard this at least the time it takes to transmit 3.5 characters. This time allows the master (PC) to perform the switching of the data direction (from send to receive), but also serves to recognize the beginning of a new telegram.

Especially the switching of the data direction on master side depends on the used hardware (PC, RS485 interface or interface converter). If the response time is selected too short the response of the device may not be recognized. In this case the response time have to be prolonged. Take into account, that the telegram sent to change the time possibly is not acknowledged due this insufficient response time. The new response time is set after the device received the telegram.

Depending on the selected hardware version of the device up to 2 **independent** Modbus interfaces are available to the user. There settings can therefore be different.

- RS485 with Modbus/RTU protocol on plug-in position X4
- RS485 with Modbus/RTU protocol on plug-in position X8

### Modbus settings, plug-in position X4

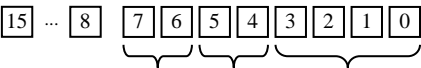
Address	Name	Type	Offset	Default	Description																								
42000	COM_ADDRESS	UINT8	0 1	1 0	Modbus address 1...247 always 0																								
42001	COM_BAUD	UINT32	0	19'200	Baud rate, valid values are: 2'400, 4'800, 9'600, 19'200, 38'400, 57'600, 115'200																								
42003	COM_OPTIONS	UNIT16	0	0x0020	Configuration of the Modbus interface  <table border="0"> <tr> <td><b>parity</b></td> <td><b>stop bits</b></td> <td><b>response time</b></td> </tr> <tr> <td><b>00:</b> None</td> <td><b>01:</b> 1</td> <td><b>0000:</b> 100 ms</td> </tr> <tr> <td><b>01:</b> Odd</td> <td><b>10:</b> 2</td> <td><b>0111:</b> 3.5 char</td> </tr> <tr> <td><b>10:</b> Even</td> <td></td> <td><b>0110:</b> 2*3.5 char</td> </tr> <tr> <td></td> <td></td> <td><b>0101:</b> 4*3.5 char</td> </tr> <tr> <td></td> <td></td> <td>↓</td> </tr> <tr> <td></td> <td></td> <td>↓</td> </tr> <tr> <td></td> <td></td> <td><b>0001:</b> 64*3.5 char</td> </tr> </table>	<b>parity</b>	<b>stop bits</b>	<b>response time</b>	<b>00:</b> None	<b>01:</b> 1	<b>0000:</b> 100 ms	<b>01:</b> Odd	<b>10:</b> 2	<b>0111:</b> 3.5 char	<b>10:</b> Even		<b>0110:</b> 2*3.5 char			<b>0101:</b> 4*3.5 char			↓			↓			<b>0001:</b> 64*3.5 char
<b>parity</b>	<b>stop bits</b>	<b>response time</b>																											
<b>00:</b> None	<b>01:</b> 1	<b>0000:</b> 100 ms																											
<b>01:</b> Odd	<b>10:</b> 2	<b>0111:</b> 3.5 char																											
<b>10:</b> Even		<b>0110:</b> 2*3.5 char																											
		<b>0101:</b> 4*3.5 char																											
		↓																											
		↓																											
		<b>0001:</b> 64*3.5 char																											

### Modbus settings, plug-in position X8

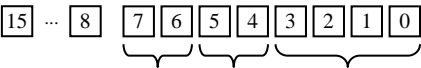
Address	Name	Type	Offset	Default	Description																								
44954	COM_ADDRESS	UINT8	0 1	1 0	Modbus address 1...247 always 0																								
44955	COM_BAUD	UINT32	0	19'200	Baud rate, valid values are: 2'400, 4'800, 9'600, 19'200, 38'400, 57'600, 115'200																								
44957	COM_OPTIONS	UNIT16	0	0x0020	Configuration of the Modbus interface  <table border="0"> <tr> <td><b>parity</b></td> <td><b>stop bits</b></td> <td><b>response time</b></td> </tr> <tr> <td><b>00:</b> None</td> <td><b>01:</b> 1</td> <td><b>0000:</b> 100 ms</td> </tr> <tr> <td><b>01:</b> Odd</td> <td><b>10:</b> 2</td> <td><b>0111:</b> 3.5 char</td> </tr> <tr> <td><b>10:</b> Even</td> <td></td> <td><b>0110:</b> 2*3.5 char</td> </tr> <tr> <td></td> <td></td> <td><b>0101:</b> 4*3.5 char</td> </tr> <tr> <td></td> <td></td> <td>↓</td> </tr> <tr> <td></td> <td></td> <td>↓</td> </tr> <tr> <td></td> <td></td> <td><b>0001:</b> 64*3.5 char</td> </tr> </table>	<b>parity</b>	<b>stop bits</b>	<b>response time</b>	<b>00:</b> None	<b>01:</b> 1	<b>0000:</b> 100 ms	<b>01:</b> Odd	<b>10:</b> 2	<b>0111:</b> 3.5 char	<b>10:</b> Even		<b>0110:</b> 2*3.5 char			<b>0101:</b> 4*3.5 char			↓			↓			<b>0001:</b> 64*3.5 char
<b>parity</b>	<b>stop bits</b>	<b>response time</b>																											
<b>00:</b> None	<b>01:</b> 1	<b>0000:</b> 100 ms																											
<b>01:</b> Odd	<b>10:</b> 2	<b>0111:</b> 3.5 char																											
<b>10:</b> Even		<b>0110:</b> 2*3.5 char																											
		<b>0101:</b> 4*3.5 char																											
		↓																											
		↓																											
		<b>0001:</b> 64*3.5 char																											

Modificat.	Date	Vis.:	Type:	APLUS	Page: 27 / 32	Author: 22.10.10 RR
2014-018	04.06.14	RR	Description:	<b>Modbus interface</b>	No.:	W 157 695

## 9 Simulation mode

By means of the simulation values of analog outputs resp. states of digital inputs or outputs, as wells as states of logic equations of the logic module may be predefined. This mode is suited especially to test subsequent circuits during commissioning.

Once started the simulation mode can be stopped two ways:

- ▶ setting the register SIM\_MOD to 0
- ▶ switching off the power supply

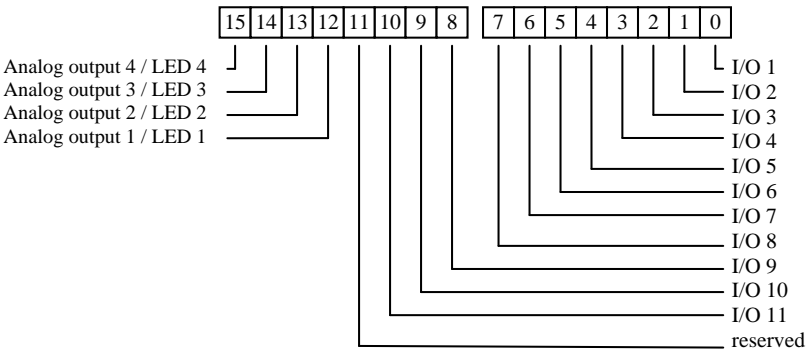
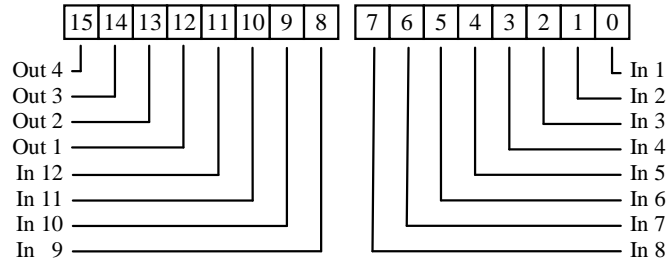
Address	Name	Type	Description
41700	SIM_MOD	UINT16	Simulation mode (0 = OFF) <i>Bit Meaning</i> 0 Logic inputs (1=start, 0=stop) 1 Logic outputs (1=start, 0=stop) 2 Analog outputs (1=start, 0=stop) 3 Digital I/Os, LED's + relays (1=start, 0=stop)
41701	SIM_OUT1	UINT16	Bit mask for simulation  <p>If the simulation of analog outputs and digital I/O's is started at the same time the simulation of the LED's is suppressed. The LED's may be simulated only, if the simulation of the analog outputs is not active at the same time. For devices with TFT display no LEDs can be simulated.</p>
41702	SIM_OUT2	UINT16	Bit mask for simulation of logic inputs 1..12 and logic outputs 

- ▶ The I/O's 4...11 are available for device versions with I/O extension only

Modificat.	Date	Vis.:	Type:	APLUS	Page: 28 / 32	Author: 22.10.10 RR
2014-018	04.06.14	RR	Description:	<b>Modbus interface</b>	No.:	W 157 695

## 9.1 Simulation of digital outputs, Relays and LED's

### Starting the simulation

Address	Name	Description
41700	SIM_MOD	8
41701	SIM_OUT1	<p>Which digital channels shall be simulated ?</p> <p>For device with TFT display no LED's can be simulated.</p>
41702	SIM_OUT2	Not used

**Setting states:** For all channels selected via SIM\_OUT1 a state may be predefined

Address	Name	Type	Description
1	IO1	COIL	State I/O 1: Relay 1
2	IO2	COIL	State I/O 2: Digital input
3	IO3	COIL	State I/O 3: Digital output
4	IO4	COIL	State I/O 4: Relay 2
5	IO5	COIL	State I/O 5: Relay 3
6	IO6	COIL	State I/O 6: Digital input / output
7	IO7	COIL	State I/O 7: Digital input / output
8	IO8	COIL	State I/O 8: Digital input / output
9	IO9	COIL	State I/O 9: Digital input / output
10	IO10	COIL	State I/O 10: Digital input / output
11	IO11	COIL	State I/O 11: Digital input / output
12	-	COIL	reserved
13	LED1	COIL	State LED 1
14	LED2	COIL	State LED 2
15	LED3	COIL	State LED 3
16	LED4	COIL	State LED 4

## 9.2 Simulation of analog outputs

### Starting the simulation

Address	Name	Description																
41700	SIM_MOD	4																
41701	SIM_OUT1	Which analog output channels shall be simulated ? <div style="text-align: center;"> <table border="1" style="display: inline-table; border-collapse: collapse;"> <tr> <td>15</td><td>14</td><td>13</td><td>12</td><td>11</td><td>10</td><td>9</td><td>8</td> <td>7</td><td>6</td><td>5</td><td>4</td><td>3</td><td>2</td><td>1</td><td>0</td> </tr> </table> </div> <div style="display: flex; align-items: center;"> <div style="margin-right: 10px;">           Analog output 4            Analog output 3            Analog output 2            Analog output 1         </div> </div>	15	14	13	12	11	10	9	8	7	6	5	4	3	2	1	0
15	14	13	12	11	10	9	8	7	6	5	4	3	2	1	0			
41702	SIM_OUT2	Not used																

**Setting output values:** For all channels selected via SIM\_OUT1 a value may be predefined

Address	Name	Type	Description
41520	AOUT1	REAL	Analog output 1 in mA
41522	AOUT2	REAL	Analog output 2 in mA
41524	AOUT3	REAL	Analog output 3 in mA
41526	AOUT4	REAL	Analog output 4 in mA

Modificat.	Date	Vis.:	Type:	<i>APLUS</i>	Page: 30 / 32	Author: 22.10.10 RR
2014-018	04.06.14	RR	Description:	<b>Modbus interface</b>	No.: W 157 695	

### 9.3 Simulation of logical functions

#### Starting the simulation

Address	Name	Description																
41700	SIM_MOD	1 (logical inputs) or 2 (logical outputs)																
41701	SIM_OUT1	Which states shall be simulated ? <div style="text-align: center;"> <table border="1" style="margin: 0 auto;"> <tr> <td>15</td><td>14</td><td>13</td><td>12</td><td>11</td><td>10</td><td>9</td><td>8</td><td>7</td><td>6</td><td>5</td><td>4</td><td>3</td><td>2</td><td>1</td><td>0</td> </tr> </table> </div>	15	14	13	12	11	10	9	8	7	6	5	4	3	2	1	0
15	14	13	12	11	10	9	8	7	6	5	4	3	2	1	0			
41702	SIM_OUT2	Not used																

Functions not used in the logic module can't be simulated

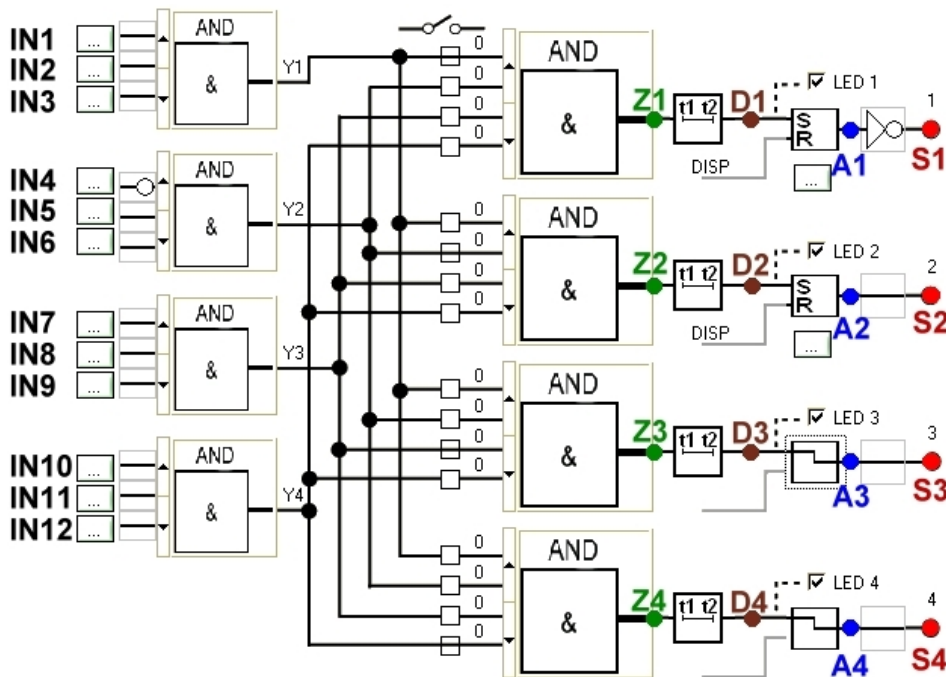

**Setting logical states:** For all channels selected via SIM\_OUT1 a state can be predefined

Address	Name	Description																
43924	LOGIC_SIMU	States of logical inputs or logical outputs <div style="text-align: center;"> <table border="1" style="margin: 0 auto;"> <tr> <td>15</td><td>14</td><td>13</td><td>12</td><td>11</td><td>10</td><td>9</td><td>8</td><td>7</td><td>6</td><td>5</td><td>4</td><td>3</td><td>2</td><td>1</td><td>0</td> </tr> </table> </div> <p>Only inputs or outputs may be simulated, never both at the same time.</p>	15	14	13	12	11	10	9	8	7	6	5	4	3	2	1	0
15	14	13	12	11	10	9	8	7	6	5	4	3	2	1	0			

## 10 Remote interface

All relays or digital outputs **not used** for the normal device functionality may be used for other purposes. Driving is performed via the configuration interface, e.g. by means of a Modbus master software.

Address	Name	Type	Description
1	IO1	COIL	State I/O 1: Relay 1
2	IO2	COIL	State I/O 2: Digital input
3	IO3	COIL	State I/O 3: Digital output
4	IO4	COIL	State I/O 4: Relay 2
5	IO5	COIL	State I/O 5: Relay 3
6	IO6	COIL	State I/O 6: Digital input / output
7	IO7	COIL	State I/O 7: Digital input / output
8	IO8	COIL	State I/O 8: Digital input / output
9	IO9	COIL	State I/O 9: Digital input / output
10	IO10	COIL	State I/O 10: Digital input / output
11	IO11	COIL	State I/O 11: Digital input / output
12	-	COIL	reserved
13	-	COIL	reserved
14	-	COIL	reserved
15	-	COIL	reserved
16	-	COIL	reserved

► The I/O's 4...11 are available for device versions with I/O extension only

Modificat.	Date	Vis.:	Type:	<i>APLUS</i>	Page:	32 / 32	Author:	22.10.10 RR
2014-018	04.06.14	RR	Description:	<b>Modbus interface</b>	No.:	W 157 695		