

METRALINE RLO-CHECK

Digital, low resistance measuring instrument per EN 61557-4 / VDE 0413-4 with cable reel and 30 m cable for measuring the resistance of protective conductors and equipotential bonding conductors

Subject to change without notice • PDF version available on the Internet

GOSSEN METRAWATT
GMC-I Messtechnik GmbH
Südwestpark 15
90449 Nürnberg • Germany

Phone +49 911 8602-111
Fax +49 911 8602-777
E-Mail info@gossenmetrawatt.com
www.gossenmetrawatt.com

CONDENSED INSTRUCTIONS:

Belt: Lay the belt around your waist and adjust it.

«Ω» terminal: Connect the measurement coil cable to this terminal. This in turn must be connected to a telescoping rod or a test probe.

4 mm banana plug: Connect an alligator clip or a PE adapter for electrical outlets to this plug

«φ» key: Press and hold this key until you hear a double acoustic signal.

Alligator clip or PE adapter for electrical outlets:

Connect this (these) to the selected equipotential bonding reference measurement point (e.g. the ground pin of an electrical outlet).

Test probe or telescoping rod: Connect this/these to the protective conductor.

Display: Read resistance (in ohms) which was measured between the alligator clip (or the PE adapter for electrical outlets) and the test probe (or the telescoping rod).

A SWITCHING THE INSTRUMENT ON :

- (The METRALINE RLO-CHECK is switched off.) Press and hold the « φ » until you hear a double acoustic signal.

The display is activated. The METRALINE RLO-CHECK is ready for measurement. The last conducted balancing procedure is active. The acoustic signal is not suppressed.

B SWITCHING THE INSTRUMENT OFF :

- (The METRALINE RLO-CHECK is switched on.) Press and hold the « φ » key for at least 2 seconds.

C DEACTIVATING THE ACOUSTIC SIGNAL :



- (The acoustic signal is not suppressed.) Briefly press the « φ » key.

The  icon appears. The acoustic signal is deactivated (the acoustic signals for balancing and the voltage alarm remain activated).

D ACTIVATING THE ACOUSTIC SIGNAL :

- (The acoustic signal is deactivated.) Briefly press the « φ » key.

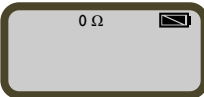
E BALANCING RESISTANCE OF THE ACCESSORIES :

- (The METRALINE RLO-CHECK is switched on). Connect the telescoping rod or the test probe to the measurement coil cable and connect the cable to the « Ω » terminal.
- Roll out the cable from the cable retractor and connect the end of the cable to the alligator clip or the PE adapter for electrical outlets.
- Activate the balancing procedure by briefly pressing the « φ » key twice. « 0 Ω » is displayed.
- Contact the end of the telescoping rod or the test probe with the alligator clip or the PE adapter for electrical outlets for several seconds. 
- Blue background, 0.00, two short acoustic signals followed by a continuous acoustic signal** indicate that balancing has been successfully completed (the displayed value may fluctuate due to measuring tolerance, for example between 0.00 and 0.07). 

The METRALINE RLO-CHECK is ready for measurement. The results of this balancing procedure are retained until balancing is conducted again, even if the battery is replaced or the METRALINE RLO-CHECK is turned off.



Red background, E01 and 0 Ω icon: Balancing has not been successful (e.g. because resistance to be eliminated is too high or the alligator clip didn't correctly contact the end of the telescoping rod etc.). Results of the previous balancing procedure remain active. Switch the METRALINE RLO-CHECK off.

F MEASURING PROTECTIVE CONDUCTOR RESISTANCE IN THE INSTALLATION :

- (The METRALINE RLO-CHECK is switched on). Connect the telescoping rod or the test probe to a measurement coil cable and connect the cable to the « Ω » terminal.
- Roll out the cable from the cable retractor and connect the end of the cable to the alligator clip or the PE adapter for electrical outlets.
- Connect the alligator clip or the PE adapter for electrical outlets with the selected equipotential bonding reference point (control panel, earth electrode, pin in an electrical outlet etc.).
- Contact the protective conductors located nearby with the telescoping rod or the test probe. **Important note!** If resistance of the accessories has not been balanced (see E), displayed resistance includes the accessories.

One of the following displays appears:



Red background, lightning bolt icon and brief acoustic signals: DANGER, interference voltage. The interference voltage value is displayed.

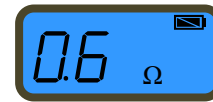

Blue background and continuous acoustic signal: Resistance ≤ 1.00 Ω, e. g. 0.64 Ω.



Red background: Resistance between 1 Ω and 20 Ω, e. g. 3.28 Ω.

G BALANCING RESISTANCE OF THE ACCESSORIES AT THE 2 TERMINALS :

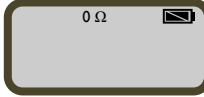
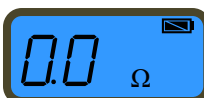
- (The METRALINE RLO-CHECK is switched on). Connect the telescoping rod or the test probe to the measurement coil cable and connect the cable to the « Ω » terminal.
- Connect a second test probe to a measurement cable and connect the cable to the « AUX » terminal.
- Briefly press the « φ » key twice. « 0 Ω » is displayed.
- Contact both ends of the telescoping rod or the test probe for several seconds. (While doing so, you can leave the alligator clip or the PE adapter for electrical outlets connected to the equipotential bonding reference measuring point). 
- Blue background, 0.00, two short acoustic signals followed by a continuous acoustic signal** indicate that balancing has been successfully completed (the displayed value may fluctuate due to measuring tolerance, for example between 0.00 and 0.07). 

The METRALINE RLO-CHECK is ready for measurement. The results of this balancing procedure are retained until balancing is conducted again, even if the battery is replaced or the METRALINE RLO-CHECK is turned off.



Red background, E01 and 0 Ω icon: Balancing has not been successful (e.g. because resistance to be eliminated is too high or the test probe didn't correctly contact the end of the telescoping rod etc.). Results of the previous balancing procedure remain active. Switch the METRALINE RLO-CHECK off. Switch the METRALINE RLO-CHECK off.

H MEASURING PROTECTIVE CONDUCTOR RESISTANCE OF A DEVICE NOT CONNECTED TO THE CABLE REEL :

- (The METRALINE RLO-CHECK is switched on). Connect the telescoping rod or the test probe to the measurement coil cable and connect the cable to the « Ω » terminal.
- (The cable from the cable retractor which is connected to the selected equipotential bonding reference point can remain connected.)
- Connect an additional test probe to a further measurement cable and connect the cable to the « AUX » terminal.
- Contact all accessible metal parts (of the device which is not connected to the cable from the cable reel) and the protective conductor of the device plug. **Important note!** If resistance of the accessories has not been previously balanced (see G), the displayed resistance includes the accessories.

One of the following displays appears:



Red background, lightning bolt icon and brief acoustic signals: DANGER, interference voltage. The interference voltage value is displayed.



Blue background and continuous acoustic signal: Resistance ≤ 1.00 Ω, e. g. 0.64 Ω.



Red background: Resistance between 1 Ω and 20 Ω, e. g. 6.90 Ω.

I USING ONLY THE CABLE FROM THE REEL COMBINED WITH AN ALTERNATIVE MEASURING INSTRUMENT :

During routine daily work, a simple extension is frequently required for connection to another measuring instrument. This is possible with the help of the « AUX » terminal.

- (The METRALINE RLO-CHECK is switched on). Undo all connections (terminals and role-up cable).
- Press and hold the « φ » key for at least 2 seconds in order to switch the device off.
- Connect the alternative measuring instrument to a measurement cable and connect the cable to the « AUX » terminal.

The cable on the cable retractor is now available for use as an extension cable. The circuit set up in this way is protected by the internal fuse in the METRALINE RLO-CHECK. The METRALINE RLO-CHECK must remain switched off and may never be switched on when an external measuring instrument is connected.

J REPLACING THE BATTERIES :

- (The METRALINE RLO-CHECK is switched on). Undo all connections (terminals and role-up cable).
- Press and hold the « ϕ » key for at least 2 seconds in order to switch the device off.
- You'll need four AA batteries and a 4 mm flathead screwdriver.
- Loosen and remove the screw (J1), and remove the battery compartment lid (J2).
- Replace the 4 batteries (J3).
- Replace the battery compartment lid (J2) and retighten the screw (J1).
- Press and hold the « ϕ » key for at least 2 seconds in order to switch the device back on.

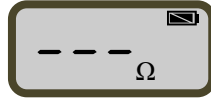

The display is active. The METRALINE RLO-CHECK is ready for measurement. The last conducted balancing procedure is active. The acoustic signal is not suppressed.

Battery full icon: maximum capacity (see « Your Safety and Attributes »).



Battery half depleted icon: 50% remaining capacity



Blinking battery low icon: 15% remaining capacity, fluctuating measurement accuracy



Blinking battery depleted icon, E03 : Measurement is not possible.



K CHANGING THE FUSE :

- (The METRALINE RLO-CHECK is switched on). Undo all connections (terminals and role-up cable).
- Press and hold the « ϕ » key for at least 2 seconds in order to switch the device off.
- You'll need two Phillips head screwdrivers (Pz-2 and Pz-4) and a 4 mm flathead screwdriver.
- Loosen the screw (J1) with the 4 mm flathead screwdriver and remove the battery compartment lid (J2).
- Loosen the 4 screws (K1) underneath the battery compartment lid with the Pz-4 Phillips head screwdriver.
- Loosen the other 2 screws (K2) in the housing base (K4) with the Pz-2 Phillips head screwdriver.
- Remove the housing base.
- Remove the fuse (K3).
- Replace it with a fuse with the following technical data: 6.3 x 32 mm, 500 mA~, 30 kA, 690 V~
- Reattach the housing base (K4).
- Replace the battery compartment lid (J2) and retighten the screw (J1).
- Press and hold the « ϕ » key until you hear a double acoustic signal in order to switch the device back on again.

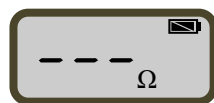

The display is active. The METRALINE RLO-CHECK is ready for measurement. The last obtained balancing results are activated. The acoustic signal is active.

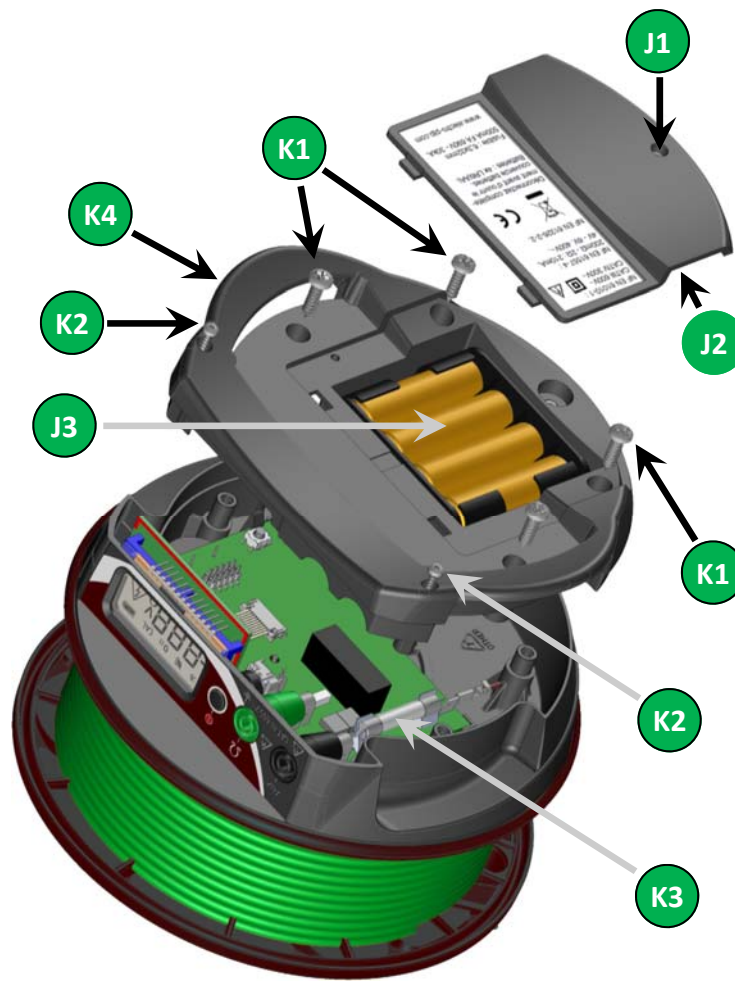

EXPLODED VIEW

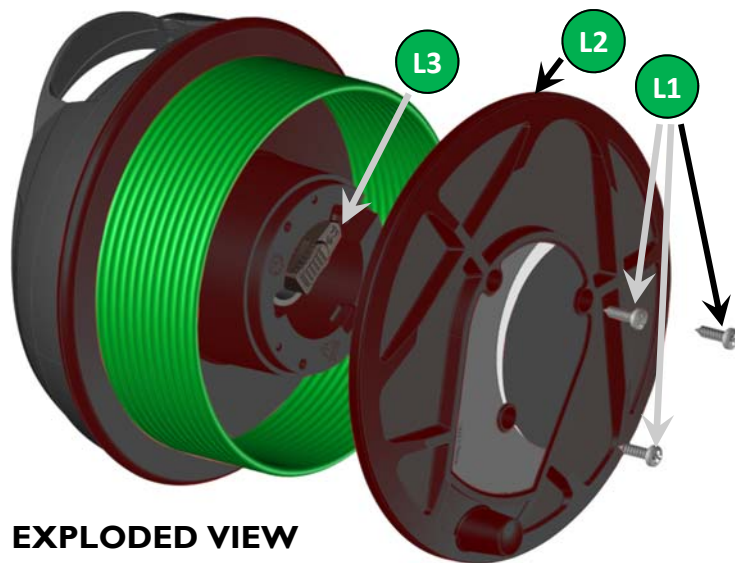

EXPLODED VIEW

L REPLACING THE CABLE :

- (The METRALINE RLO-CHECK is switched on). Undo all connections (terminals and role-up cable).
- Press and hold the « ϕ » key for at least 2 seconds in order to switch the device off.
- You'll need a Pz-4 Phillips head screwdriver and a replacement cable.
- Loosen the 3 screws (L1) at the front. Remove the cover (L2).
- Pull out the plug (L3) and pull out the cable in its entirety.
- Fully unroll the replacement cable.
- Insert the curved plug at position L3.
- Replace the cover (L2).
- Roll up the cable. The METRALINE RLO-CHECK is ready for use.

SAFETY PRECAUTIONS – TECHNICAL DATA :

Protection is impaired if the instructions are not complied with.

Device protection: 400 V~ between the two device terminals or between one terminal and the cable plug. Fuse: 6.3 x 32 mm, HPC 30 kA, 500 mA~, 690 V~. Refer to section K regarding fuse replacement.

User protection (with regard to grounding): 600 V~ CAT III / 300 V~ CAT IV, reinforced insulation, class 2, pollution degree 2, per EN / IEC61010-1:2010, and 300 V~ CAT III / 300 V~ CAT IV, reinforced insulation, class 2, pollution degree 3, per EN / IEC61010-1:2010. IP2X per EN / IEC60529:2001.

Where protection of the METRALINE RLO-CHECK and accessory components is concerned, connection of the METRALINE RLO-CHECK to accessory components offers the weakest protection.

~ Alternating current

⏻ ON / OFF

⚠ Attention! Observe these operating instructions.

⚡ Attention! Danger of electric shock

⚡ Device extensively protected by reinforced insulation

⏚ Ground conductor

CAT III (measuring category III). This is the building's electrical installation environment. It encompasses electrical socket bases, fuse panels etc.

CAT IV (measuring category IV). This is the building's electrical installation environment or the environment in the building between the infeed and the mains distribution board including electric meters etc.

Pollution degree 2: Usual contamination, not conductive. However, intermittent conductivity due to condensation must be expected. A conventional environment is classified as pollution degree 2.

Pollution degree 3: Presence of conductive or non-conductive dry contamination which becomes conductive due to any condensation which may occur.

Ambient conditions: Pollution degree 2 (conventional environment) or 3 (see above), temperature range for operation and storage: -20 °C to +55 °C, maximum relative atmospheric humidity: 80% for temperatures up to 31 °C, linear reduction of relative atmospheric humidity down to 50% at 40 °C. Do not immerse the device. Protect against liquids, rain and in general against influences due to weather. The device may not be used in potentially explosive atmospheres or moist environments.

Max. amperage within the cable (when used only as a cable retractor, see I): 0.5 A (protected by fuse).

Warning regarding interference voltage: In the event of interference voltage at the protective conductors, resistance measurement with the METRALINE RLO-CHECK is disabled. An intermittent acoustic signal is generated, the color of the display is changed to red and the interference voltage value is displayed. If a minus sign (-) appears to the left of this value, the interference voltage is direct voltage and otherwise alternating voltage. The TRMS value (superimposed, sinusoidal alternating voltage) is displayed. Input impedance: 300 kΩ. Warning range: 8 V~ / GS to 400 V~ / GS.

Maximum compensation value: 4 Ω.

Power supply: 4 AA alkaline batteries (rechargeable AA batteries can be used but they reduce the duration of use).

Duration of use: Approx. 1.7 days under normal conditions of use at 20 °C with new batteries. Approx. 5 hours and 50 minutes for continuous measurement of volume resistance of an earthing conductor of less than 1 Ω with activated acoustic signal and new batteries. The instrument is switched off automatically after five minutes of nonuse.

Conformity with standards: EN / IEC61010-1:2010, EN / IEC61557-4:2007.

Conformity with European directives: 2011/65/EC « RoHS directive », 2006/95/EC « low-voltage directive », 2006/96/EC « WEEE directive », 2004/108/EC « EMC directive ».

Volume resistance measuring method: Current between 200 and 210 mA, voltage between 4 and 24 V, automatic polarity reversal, in accordance with EN / IEC61557-4:2007.

Functional safety of volume resistance per EN61557-4: ±0.07 Ω from 0.00 Ω to 0.50 Ω, ±10 % ±0.02 Ω from 0.50 Ω to 2.00 Ω and ±8 % at above 2.00 Ω.

In order to assure that measuring accuracy is not impaired in the following cases:
 - Interchanging of accessories,
 - Relocation to another environment (significant change in temperature or relative atmospheric humidity),
 - Swapping of the cable plug connections (connection to the cable plug instead of the « AUX » terminal and vice versa).

Balance the utilized accessories before performing the respective measurement (see sections E and G), and replace the batteries if the battery symbol blinks.

Volume resistance measuring range: 0.00 Ω to 20.0 Ω.

Display resolution for volume resistance: 0.00 Ω to 9.99 Ω and 10.0 Ω to 20.0 Ω.

The METRALINE RLO-CHECK cannot be used for testing for the absence of voltage. Do not use it for this type of testing. Conduct visual inspection of the instrument before use. Do not use the measuring instrument if it's damaged. If the instrument generates an interference voltage warning, check the electrical installation.

Compatible electrical installations:

3-phase current, 4-wire, with grounded neutral point,
 3-phase current, 3-wire, not grounded,
 3-phase current, 3-wire, with grounded neutral point,
 single-phase current, 2-wire and
 single-phase current, 3-wire.

Volume resistance of conductors is measured with the METRALINE RLO-CHECK regardless of whether or not the electrical installation is energized. The conductors to be tested must be voltage free, but the electrical system can be energized. Measurement results may be distorted due to impedances from additional, parallel connected circuits or transient current.

USE :

The METRALINE RLO-CHECK is a test instrument for checking the continuity of protective conductors and equipotential bonding.

Use of the instrument is described in detail in the previous pages. The measuring instrument is worn by the user using the included belt which is placed around the waist. It can be used to test the continuity of protective conductors and equipotential bonding conductors in electrical systems. As a rule, these electrical systems are energized while the user is conducting testing with the METRALINE RLO-CHECK. The METRALINE RLO-CHECK may only be used to test conductors whose potential is practically 0 V under normal conditions.

With the help of the acoustic and luminous signals generated by the METRALINE RLO-CHECK, the user determines whether or not the continuity of the protective and equipotential bonding conductors has an electrical resistance of no greater than 1 Ω.

Beyond this, the user can read a value of up to 20 Ω for electric resistance from the display.

Only connect the METRALINE RLO-CHECK to accessories (cables, test probes, telescoping rod, terminals, alligator clips etc.) from GOSSEN METRAWATT with measuring categories of at least 600 V~ CAT III / 300 V~ CAT IV.

The METRALINE RLO-CHECK may only be used by qualified persons who are aware of the associated hazards and have received training concerning the safety precautions which are necessary in order to prevent injury which may result from the use of the instrument under certain circumstances.

The system installation technician is responsible for the safety of the overall system into which the METRALINE RLO-CHECK is integrated.

Clean the various parts of the instrument with a soft cotton cloth which has previously been slightly moistened with a solution consisting of 50% water and 50% cleaning agent. The METRALINE RLO-CHECK must be entirely disconnected for cleaning. Dry all parts completely before connecting the instrument to electrical power.

Do not open the battery compartment (J2) while the METRALINE RLO-CHECK is connected to a measuring circuit or the display is active.

Do not install any fuses other than those recommended (K3).

Each time before using the measurement instrument, inspect the METRALINE RLO-CHECK for possible damage. Any and all components with damaged insulation (even if it's only partially damaged) must be removed and disposed of.

METRALINE RLO-CHECK

Digital, low resistance measuring instrument per EN 61557-4 / VDE 0413-4 with cable reel and 30 m cable for measuring the resistance of protective conductors and equipotential bonding conductors



CONDENSED INSTRUCTIONS:

Belt: Lay the belt around your waist and adjust it.

« Ω » terminal: Connect the measurement coil cable to this terminal. This in turn must be connected to a telescoping rod or a test probe.

4 mm banana plug: Connect an alligator clip or a PE adapter for electrical outlets to this plug.

« φ » key: Press and hold this key until you hear a double acoustic signal.

Alligator clip or PE adapter for electrical outlets: Connect this (these) to the selected equipotential bonding reference measurement point (e.g. the ground pin of an electrical outlet).

Test probe or telescoping rod: Connect this (these) to the protective conductor.

Display: Read resistance (in ohms) which was measured between the alligator clip (or the PE adapter for electrical outlets) and the test probe (or the telescoping rod).

TECHNICAL DATA:

Protection is impaired if the instructions are not complied with.

Device protection: 400 V~ between the two device terminals or between one terminal and the cable plug. Fuse: 6.3 mm x 32 mm, HPC 30 kA, 500 mA~, 690 V~. Refer to section K regarding fuse replacement.

User protection (with regard to grounding):

600 V~ CAT III / 300 V~ CAT IV, reinforced insulation, class 2, pollution degree 2, per EN / IEC61010-1:2010, and 300 V~ CAT III / 300 V~ CAT IV, reinforced insulation, class 2, pollution degree 3, per EN / IEC61010-1:2010. IP2X per EN / IEC60529:2001.

Where protection of the METRALINE RLO-CHECK and accessory components is concerned, connection of the METRALINE RLO-CHECK to accessory components offers the weakest protection.

Ambient conditions: Pollution degree 2 (conventional environment) or 3 (see above), temperature range for operation and storage: -20 C to +55 C, maximum relative atmospheric humidity: 80% for temperatures up to 31 C, linear reduction of relative atmospheric humidity down to 50% at 40 C. The test instrument may not be immersed. Protect against liquids, rain and in general against influences due to weather. The device may not be used in potentially explosive atmospheres or moist environments.

Max. amperage within the cable (when used only as a cable retractor, see I): 0.5 A (fuse protected).

Warning regarding interference voltage:

If interference voltage is applied to the protective conductors, resistance measurement is disabled. An intermittent acoustic signal is generated, the color of the display is changed to red and the interference voltage value is displayed. If a minus sign (-) appears to the left of this value, the interference voltage is direct voltage and otherwise alternating voltage. The METRALINE RLO-CHECK displays the TRMS value (superimposed, sinusoidal alternating voltage). Input impedance: 300 kΩ. Warning range: 8 V~ / GS to 400 V~ / GS.

Maximum compensation value: 4 Ω.

Power supply: 4 AA alkaline batteries (rechargeable AA batteries can be used but they reduce the duration of use).

Duration of use: Approx. 1.7 days under normal conditions of use at 20 C with new batteries. Approx. 5 hours and 50 minutes for continuous measurement of volume resistance of an earthing conductor of less than 1 Ω with activated acoustic signal and new batteries. The instrument is switched off automatically after five minutes of nonuse.

Method for measuring volume resistance of the earthing conductor:

Current between 200 and 210 mA, voltage between 4 and 6 V, automatic polarity reversal, in accordance with EN / IEC61557-4:2007.

Functional safety of volume resistance per EN61557-4:

±0.07 Ω from 0.00 Ω to 0.50 Ω, ±10 % ±0.02 Ω from 0.50 Ω to 2.00 Ω and ±8 % at above 2.00 Ω.

In order to assure that measuring accuracy is not impaired in the following cases:

- Interchanging of accessories,
- Relocation to another environment (significant change in temperature or relative atmospheric humidity),
- Swapping of the cable plug connections (connection to the cable plug instead of the « AUX » terminal and vice versa).

Balance the utilized accessories before performing the respective measurement (see sections E and G), and replace the batteries if the battery symbol blinks.

Volume resistance measuring range: 0.00 Ω to 20.0 Ω.

Display resolution for volume resistance:

0.00 Ω to 9.99 Ω and 10.0 Ω to 20.0 Ω.

M RECALIBRATION TO 2.00 Ω :

- (The METRALINE RLO-CHECK is switched on.) Undo all connections (terminals and role-up cable).
- Check to see if the battery icon indicates full charging (if not, replace the batteries with new ones, see section J).
- Locate the 0 Ω short-circuit jumper (M1).

Briefly press the « φ » key twice.

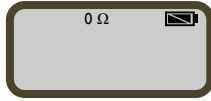

- Connect the 0 Ω shunt (M1) to the two terminals.

Wait for approximately 3 seconds.

- **Blue background, 0.00, two short acoustic signals followed by a continuous acoustic signal**

indicate that balancing has been successfully completed (the displayed value may fluctuate due to measuring tolerance, for example between 0.00 and 0.07).



- Remove the 0 Ω short-circuit jumper (M1).
- Press and hold the « φ » key for at least 2 seconds in order to switch the device off.
- Locate the 2 Ω calibrating shunt (M2) and a 4 mm flathead screwdriver.
- Loosen and remove the screw (J1), and remove the battery compartment lid (J2).
- Locate a precision screwdriver with a maximum diameter of 2 mm.
- Press and hold the « φ » key until you hear a double acoustic signal in order to switch the device back on again.
- Connect the 2 Ω calibration shunt (M2) to the two terminals.
- Using a precision screwdriver with a max. diameter of 2 mm, press the key inside the housing to recalibrate (opening M3).

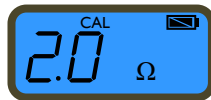
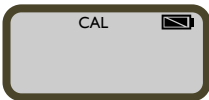

- **Blue background, 1.00, and the CAL icon** indicate that recalibration to 2.00 Ω has been successful.
- Press and hold the « φ » key for at least 2 seconds in order to switch the device off.
- Remove the 2 Ω calibration jumper (M2).
- Replace the battery compartment lid (J2) and retighten the screw (J1).
- Press and hold the « φ » key until you hear a double acoustic signal in order to switch the device back on again.
- Balance resistance to your accessories in accordance with section E or G.

The METRALINE RLO-CHECK is ready for measurement. Recalibration to 2 Ω remains effective until the next recalibration, even if the battery is replaced and/or the METRALINE RLO-CHECK is turned off.

Red background, E02 and CAL icon:



Recalibration was not successful (e.g. because the wrong calibration shunt was used etc.).

Switch the METRALINE RLO-CHECK off.

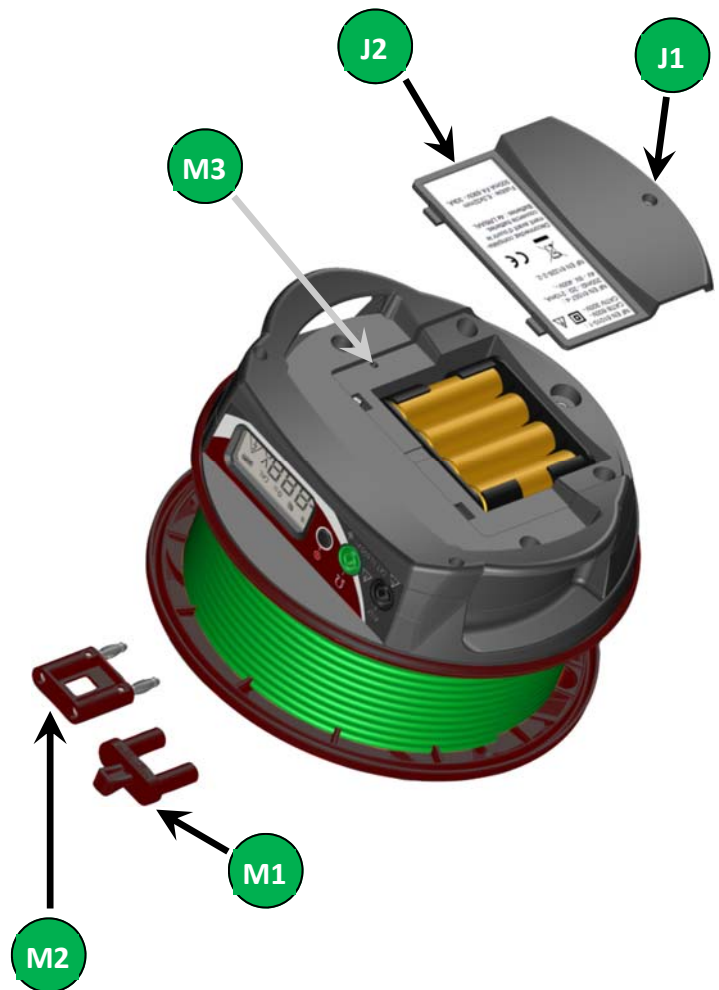

Repair and Replacement Parts Service Calibration Center and Rental Instrument Service

If required please contact:

GMC-I Service GmbH
Service Center
Beuthener Str. 41
90471 Nürnberg • Germany
Phone: +49 911 817718-0
Fax: +49 911 817718-253
E-Mail service@gossenmetrawatt.com
www.gmci-service.com

This address is only valid in Germany.
Please contact our representatives or subsidiaries
for service in other countries

Product Support

If required please contact:
GMC-I Messtechnik GmbH
Product Support Hotline
Phone +49 911 8602-0
Fax: +49 911 8602-709
E-Mail support@gossenmetrawatt.com

Subject to change without notice • PDF version available on the Internet

GOSSEN METRAWATT
GMC-I Messtechnik GmbH
Südwestpark 15
90449 Nürnberg • Germany

Phone +49 911 8602-111
Fax +49 911 8602-777
E-Mail info@gossenmetrawatt.com
www.gossenmetrawatt.com