

ENERGYMETER | MID

Electronic Active Energy Meters

U1281/U1289/U1381/U1387/U1389

3-349-618-15
4/10.20



© Gossen Metrawatt GmbH

Edited in Germany • Subject to change without notice / Errors excepted • A pdf version is available on the Internet

All trademarks, registered trademarks, logos, product names and company names are the property of their respective owners.

Gossen Metrawatt GmbH

Südwestpark 15
90449 Nürnberg
Germany

Phone +49 911 8602-111
Fax +49 911 8602-777
E-Mail info@gossenmetrawatt.com
www.gossenmetrawatt.com

1 Safety Precautions – Symbols

- Check the specified nominal voltage on the serial plate before placing the instrument into service.
- Observe the maximum voltage of the pulse output.
- Make sure the connector cables are not damaged, and that they are voltage-free while wiring the instrument.
- If it can be assumed that safe operation is no longer possible, the instrument must be immediately removed from service (disconnect input voltage!). Safe operation can no longer be relied upon if the instrument demonstrates visible damage.

The device may not be placed back into operation until troubleshooting and repair have been performed, and calibration and dielectric strength have been tested and approved at our factory or an authorized service center.

- Voltage conducting parts may be exposed if the cover is opened.

If balancing, maintenance or repair of a live open instrument is required, work may only be carried out by trained personnel who are familiar with the dangers involved. Capacitors inside the instrument may be dangerously charged, even after it has been disconnected from all power sources.

- After the instrument has once again been closed subsequent to repair or maintenance work, insulation must be tested with high-voltage in accordance with the values specified in the technical data.

Meaning of Symbols on the Instrument

DE MTP 11 B 001 MI-003 Prototype test certificate



Total insulation,
Safety Class II device



Warning concerning a source of danger
(Attention, observe documentation!)



This device may not be disposed of with the trash. Further information regarding the WEEE mark can be accessed on the Internet at www.gossenmetrawatt.com by entering the search term 'WEEE'.



Metrology label with year (M11) and registration number of the indicated authoring for module D. Duration of Calibration validity country specific



Label with seal from federally approved test authority
(for recalibration only)

Tamper-proof sealing

The manufacturer's lead seal for calibration protection is located at the back of the instrument.

Tamper-proof sealing for the terminal cover can be attached either at the left or right-hand side of the terminal cover.

2 Serial Plate – Terminals

Type designation	U1389 C E M 11 1948		Circuit Symbols
LED constant	100 000 Imp/kWh	0,01-1(6)A	U12/U1389: Y 4-L U1387: V 3-L U12/U1381: I 2-L
U_N	3x57,7/100V;63,5/110V	50Hz Cl. B	Accuracy class Reverse Action Lock
f_N			Year of manufacture
Pulse output	\square (S0): 1000 Imp/kWh(sek)	2011	External auxiliary voltage
	CT=prog. VT=prog. LON H=24V		Operating temperature range
Serial number	Nr.:UA1234567003	-25°C...55°C	
			Bus connection

CT: Current transformer transformation ratio

VT: Voltage transformer transformation ratio

The values of CT, VT and SØ on the serial plate can be / are calibrated

Note: Observe the wiring diagram in the terminal cover

Attention: Tighten screws by hand only! Tightening torque

for **current terminals** (No. 1, 3, 4, 6, 7 and 9) = **2 Nm**
 for **all other terminals** (No. 2, 5, 8, 11, 20 to 24) = **0.4 Nm**

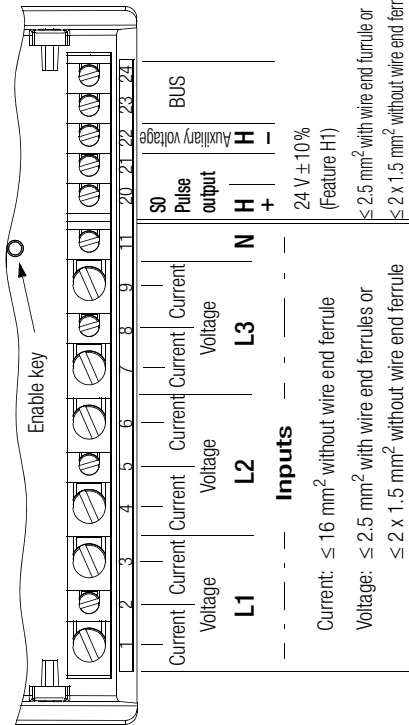

3 Pulse Output – Bus Interfaces

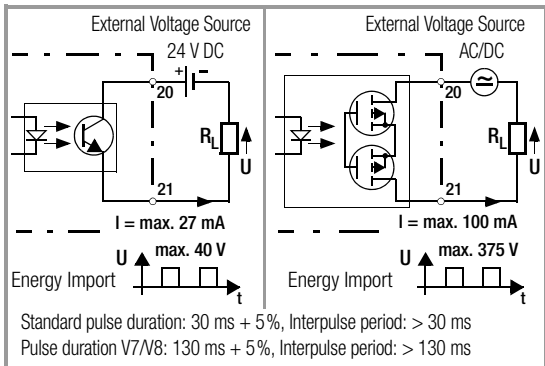

Pulse rates	fix V1/V3	V7	V8	fix V9	Programmable V2/V4
Direct	U1281 / U1289				
	1000puls./kWh	100	—	—	1 ... <u>1000</u> pulses/kWh
Transformer	U1381 / U1387 / U1389				
	f (secondary)				
CT = VT = 1 (Q0)	1000puls./kWh	100	1000	100...	1... <u>1000</u> ...10000puls./kWh
CT, VT progr. (Q1)	1000puls./kWh	100	1000	10000	1... <u>1000</u> ...10000puls./kWh
CTxVT; CT, VT fix (Q9)	f (primary)			f (primary)	
1 ... 10	1000puls./kWh			—	1 ... <u>1000</u> pulses/kWh
11 ... 100	100 pulses/kWh			—	0,1 ... <u>100</u> pulses/kWh
101 ... 1000	10 pulses/kWh			—	0,01 ... <u>10</u> pulses/kWh
1001 ... 10000	1 pulses/kWh			—	1 ... <u>1000</u> pulses/MWh
10001 ... 100000	0,1 pulses/kWh			—	0,1 ... <u>100</u> pulses/MWh
100001..1000000	0,01 puls./kWh			—	0,01 ... <u>10</u> pulses/MWh

underlined values are default values in as-delivered condition

The **interface descriptions** for the active energy meters are available on the Internet under www.gossenmetrawatt.com.

4 Display and Control Panel

4.1 Test LED

The **test LED** is located between the LCD and the serial plate. The higher the measured power value, the higher the blink rate. If all currents are lower than the starting current, the LED lights up permanently.

LED Constant

U128x: 10 000 pulses/kWh

U138x: 100 000 pulses/kWh

4.2 Resolution of Energy Import Main Display (Large Characters)

Meter Feature	CTxVT min.	CTxVT max.	Standard Reading	Calibration Reading *	Unit	
U1281, U1289	—	—	123456.7	23456.78	kWh	
U138x	Q0 or Q9	1	10	12345.67	2345.678	kWh
		11	100	123456.7	23456.78	kWh
	Q9	101	1000	1234567	234567.8	kWh
		1001	10000	12345.67	2345.678	MWh
		10001	100000	123456.7	23456.78	MWh
		100001	1000000	1234567	234567.8	MWh
	Q1	1	10	123456.7		kWh
		11	100	1234567		kWh
		101	1000	12345.67		MWh
		1001	10000	123456.7		MWh
10001		100000	1234567		MWh	

* For calibratable main displays (Q0 or Q9), the calibration reading indicates an additional digit after the decimal point. Therefore, the leading digit is omitted in the case of 7-digit presentation.

4.3 Meanings of Symbols on the LCD

Main display (active energy E_{tot}^* in kWh or MWh)

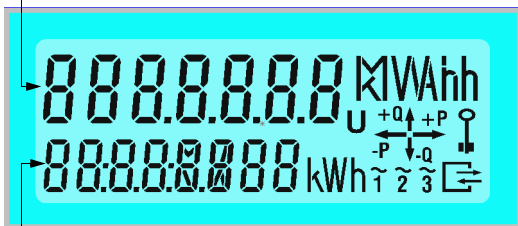

Auxiliary display (instantaneous power P_{mom}^*)

Error: alternating error code and instantaneous power

* U138x: CT and VT are taken into consideration

U **Main display** is not/cannot be calibrated, if **U** is displayed.

1 2 3

Correct connection:

Continuously lit phase symbols

Phase failure:

Symbol for affected phase is cleared from display.

Incorrect phase sequence:

Phase symbols blink in the following order: 3-2-1.

Negative power:

Respective phase symbol blinks.







4 quadrant display of instantaneous power: positive or negative active power P , positive or negative reactive power Q .







For bus connection: appears when the meter transmits a data packet.

Key Symbols for Parameters Configuration

-  **Key and 2nd key bit blanked:**
Parameters CT, VT or S0 configurable according to features, can be disabled with enable key.
-  **Key displayed with one key bit:**
Parameters CT, VT or S0 disabled, can be changed after activating enable key.
-  **Key blanked, 2nd key bit displayed:**
Parameters CT, VT or S0 (which are / can be calibrated) are preset at the factory, can be queried in the display mode, other values can be set.
-  **Key with 2nd key bit displayed:** parameters (which can be / are calibrated) are preset at the factory, other values are disabled with enable key and can be reset after cancelling the disable function.

Values which are preset at the factory are specified additionally on the serial plate in as-delivered condition.

Symbols	Adjustable parameters	Disabled parameters	Fixed/calibrated parameters	Feature
	CT, VT			Q1
	S0			V2, V4
		CT, VT		Q1
		S0		V2, V4
	CT, VT		S0	Q1 and V1/V3/V7/V8/V9
	S0		CT, VT	V2/V4 and Q0/Q9
		CT, VT	S0	Q1 and V1/V3/V7/V8/V9
		S0	CT, VT	V2/V4 and Q0/Q9
			S0, CT, VT	V1/V3 and Q0/Q9
			S0, CT, VT	V7/V8/V9 and Q0

4.4 Key Operation

Querying parameter values CT, VT and S0

Apart from the LCD test, the menu key located between LCD and serial plate serves to query current parameter values and, in the case of active energy meters with special features, to change parameters (provided that the enable key has been activated before). The sequence can be seen from the figure on the right.

If no key is pressed for 2 minutes, the display returns automatically to the standard setting.

Parameters can be changed in the following instruments:

Parameters CT, VT for U138x with feature Q1,
parameters S0 for U128x/U138x with feature V2/V4

a) Enabling parameter modifications

The enable key serves to enable or disable parameter changes. It is located below the terminal cover and is activated with a pointed object (e. g. ballpen).

Pressing the key for the first time activates operating mode „Change parameters“ (key off):

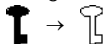

Renewed activation disables operating mode „Change parameters“ (key on):



If the key is not activated for approx. 2 minutes, operating mode „Change parameters“ is automatically aborted and blocked.

The key is displayed again:



b) Changing parameter values

- Briefly press the enable key first, as described under Item a) (activates operating mode „Change parameters“).
- Press and hold the menu key once until the read-out test is displayed.
- Repeatedly press the menu key until the parameter to be changed appears at the display.
- Press and hold the menu key until the parameter value at the digit with the highest value (on the far left-hand side) blinks.
- You can increase the value of the blinking digit by pressing the menu key (fast scroll when key is held). If the key is not activated for a few seconds, the selected digit is stored and the entry cursor moves one digit to the right. The selected value is stored when the digit with the lowest value (on the far right-hand side) stops blinking.
- Press the menu key several times until the standard display appears.
- Press the enable key once more. This disables operating mode „Change parameter values“.

Query and Configuration of LON-Bus (Feature W1) M-Bus (Feature W2) and L-Bus (Feature W3)

The interface descriptions for the active energy meters with bus connection are available on the internet under www.gossenmetrawatt.com.

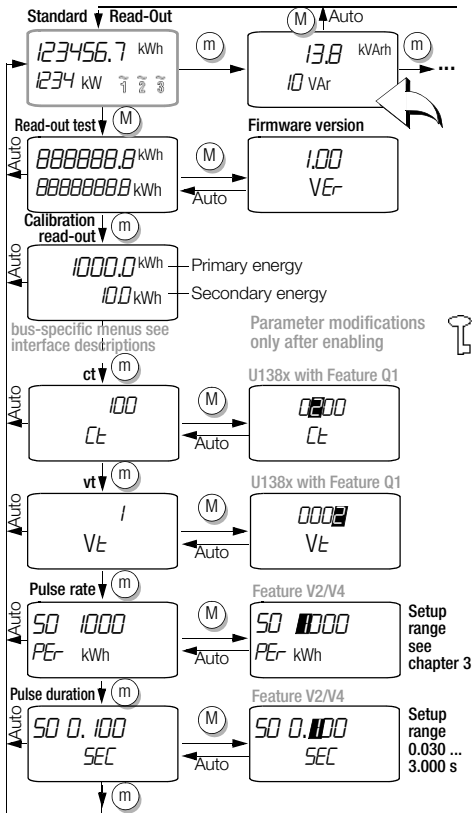

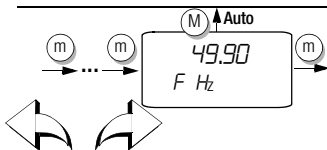

Multifunctional display		Feature	M1	M2	M3
Reactive energy	kVArh		—	•	•
Phase voltage	U1N, U2N, U3N		•	—	•
Delta voltage	U12, U23, U13		•	—	•
Current	I1, I2, I3		•	—	•
Active power	P1, P2, P3, Ptot		•	—	•
Reactive power	Q1, Q2, Q3, Qtot		•	—	•
Apparent power	S1, S2, S3, Stot		•	—	•
Power factor	PF1, PF2, PF3, PFtot		•	—	•
Frequency	F		•	—	•

Key

- Auto Automatic scrolling
- ct Transformation ratio current
- m Press the menu key briefly
- M Press and hold the menu key
- Q1 Feature: Transformation ratios programmable
- S0 Pulse rate S0 output
- vt Transformation ratio voltage
- V2/V4 Feature: rate programmable
- V9 S0 rate customized

5 Error Messages – Reset

Read-out

If an error occurs, the respective error code and instantaneous power are displayed alternately.

Error Code	Meaning	Cause/Remedy
<i>E UH_i 1</i>	Maximum value for U1 exceeded	
<i>E UH_i 2</i>	Maximum value for U2 exceeded	
<i>E UH_i 3</i>	Maximum value for U3 exceeded	
<i>E IH_i 1</i>	Maximum value for I1 exceeded	
<i>E IH_i 2</i>	Maximum value for I2 exceeded	
<i>E IH_i 3</i>	Maximum value for I3 exceeded	
<i>E SYnc</i>	Frequency measuring error	Meter connected to direct voltage
<i>E EnERGY</i>	Meter defective	Send meter to repair department
<i>E cALi b</i>	Balancing required	
<i>E AnALoG</i>	DC offset too high	

Reset

In the event of malfunction or or after eliminating an error, the device can be reset briefly by disconnecting auxiliary power or supply power.

6 Product Support

Gossen Metrawatt GmbH

Product Support Hotline

Phone +49 911 8602-500

Fax +49 911 8602-340

E-Mail support@gossenmetrawatt.com

7 Declaration of Conformity



EU-KONFORMITÄTSERKLÄRUNG
DECLARATION OF CONFORMITY



Dokument-Nr./ Document-no: 20-6-002 CSA Group Bayern GmbH (NB 1948) Annex MI-003
EU-Baumusterprüfbescheinigung Nr.: DE MTP 11 B 001 MI-003

Hersteller/ Manufacturer: Gossen Metrawatt GmbH
Anschrift / Address: Südwestpark 15
D - 90449 Nürnberg
Produktbezeichnung/ Product name: Wirkenergiezähler mit LCD
Active energy meter with LCD
Typ / Type: EnergyMETER
Artikel-Nr / Article no: U1281 / U1289 / U1381 / U1387 / U1389

Das bezeichnete Produkt stimmt mit den Vorschriften folgender Europäischer Richtlinien überein, nachgewiesen durch die vollständige Einhaltung folgender Normen:

The above mentioned product has been manufactured according to the regulations of the following European directives proven through complete compliance with the following standards:

Nr. / No.	Richtlinie	Directive
2014/32/EU	Messgeräte, Elektrizitätszähler für Wirkverbrauch (MI 003) - MID Richtlinie -	Measuring Instruments, Active Electrical Energy Meters (MI 003) - MID Directive -

DIN EN/Norm/Standard

DIN EN 50470-1 : 2007-05
DIN EN 50470-3 : 2007-05

Nr. / No.	Richtlinie	Directive
2014/30/EU	Elektromagnetische Verträglichkeit - EMV Richtlinie -	Electromagnetic Compatibility - EMC directive -

Grundnorm / Generic Standard

DIN EN 50470-1 : 2007-05

Nürnberg, den 27.10.2020

Ort, Datum / Place, date:

Diese Erklärung bescheinigt die Übereinstimmung mit den genannten Richtlinien, beinhaltet jedoch keine Zusicherung von Eigenschaften. Die Sicherheitshinweise der mitgelieferten Produktdokumentationen sind zu beachten.

Geschäftsführung / managing director

This declaration certifies compliance with the above mentioned directives but does not include a property/guarantee. The safety notes given in the product documentations, which are part of the supply, must be observed.

8 Repair and Recalibration

Note for Test Laboratories

Directly measuring meters (U128X):

In as-delivered condition, screw terminals 2, 5 and 8 are tightened in order to establish contact between current and voltage inputs.

If isolated voltage supply is required for tests, the screw terminals can be released (remove screw cover, release screws, pull insulating sleeves over contact pins in the terminals and connect simulator voltage).

Calibration Reading

For testing and calibration purposes the energy values can be displayed with a higher resolution. Press the menu key, as shown in the flowchart in chapter 4.4. Refer to chapter 4.2 for the type and feature dependant resolutions.

Recalibration by our federally approved test authority EB-8 is possible at any time.

GMC-I Service GmbH

Service Center

Beuthener Straße 41

90471 Nürnberg • Germany

Phone +49 911 817718-0

Fax +49 911 817718-253

E-Mail service@gossenmetrawatt.com

www.gmci-service.com

This address is only valid in Germany.

Please contact our representatives or subsidiaries for service in other countries.