

SECUTEST BASE(10) / PRO **and SECULIFE ST BASE(25)**

Tester for Measuring the Electrical Safety of Devices
per VDE 0701-0702, IEC 62353 and IEC 60974-4

3-447-053-03
1/6.19

Important

Read carefully before use.

Recommendation: Keep on file for future reference!



Please read the full operating instructions as well,
which are available as a PDF file at

www.gossenmetrawatt.com.

The condensed operating instructions do not
replace the full operating instructions!

Operating and Connection Overview

Symbol display for devices connected to the USB master interface see below

USB ports

2 USB master

- For keyboard
- For scanner
- For printer
- For USB stick

USB slave

- For PC

Special Symbol Displays:

- Measurement at IT line active
- OFFSET for RPE active

Symbol: mains to test socket

White/silver identified and fused high current path

Fuse compartment

Voltage measurement

test probe
Kink protection grommet:
black: max. 16 A
green: max. 25 A

Connection for voltage supply
SECUTEST CLIP (Z745H)

LCD panel⁽¹⁾

Sockets
2nd test probe⁽²⁾

Fixed Function Keys

PRINT: Print via USB

ESC: Return

HELP: Help images

MEM: Database

START: Start/stop
- Single meas.
- Test seq.
Finger contact

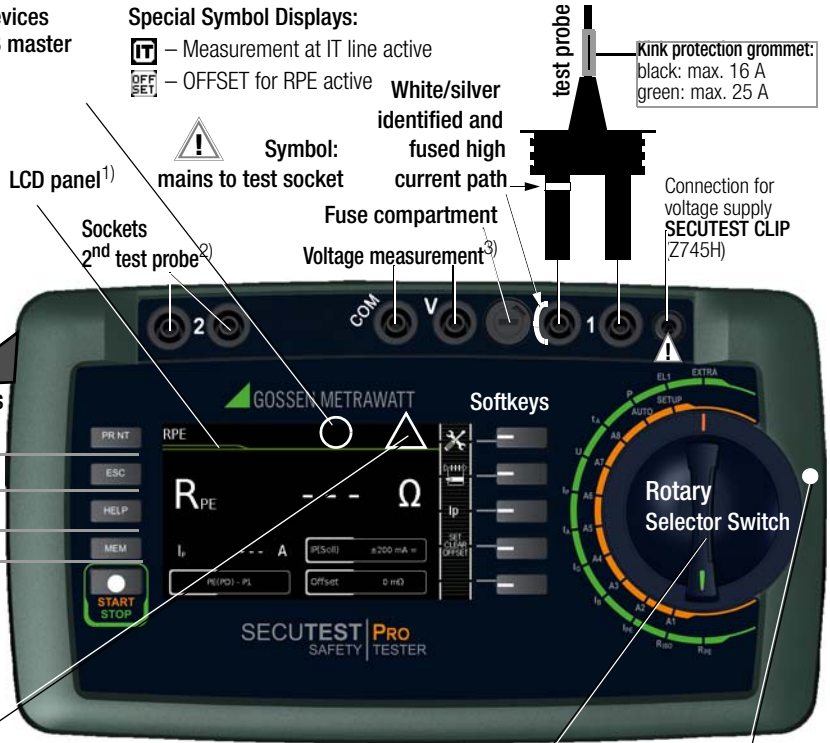

Netz an Prüfdose
SFC: Normalzustand

Netz an Prüfdose
SFC: N unterbrochen

Rotary switch level: orange
Test sequences A1 ... A8, AUTO
(test sequences per standard)

Rotary switch level: green
Single measurements

Test socket for connecting DUTs

Caution!
Depending on the measuring task, the test probe may be charged with line voltage.

Overview of Differences in Features

SECUTEST...	Feature	BASE	BASE10	PRO	PRO BT comfort	—
SECULIFE...		—	—	ST BASE	—	ST BASE25
Touch Screen/Keyboard	E01			•	•	•
10 A RPE test current	G01		•	•	•	
25 A RPE test current	G02					•
2 nd test probe	H01			•	•	•
Voltage meas. inputs	I01			•	•	•
SECUTEST DB+	KB01			•	•	•
SECUTEST DB comfort	KD01				•	•
Bluetooth®	M01				•	
Antimicrobial housing	—			ST BASE		•

Table of Contents	Page	Page	
1 Safety Precautions	4	8.14 EXTRA – Special functions	25
2 Initial Start-Up	6	8.15 2-Pole Measurements with P1 and P2 Test Probes	27
2.1 Mains Connection	6	8.16 Measurement with Current Clamp Sensor at Permanently Installed DUTs of Safety Class I	27
2.2 Detection of Mains Connection Errors	6	8.17 Measurements with Test Adapter	28
3 Overview of Functions		9 Test Sequences in Accordance with Standards	29
Included with SECUTEST BASE(10)/PRO and SECULIFE ST BASE Testers	7	9.1 General Procedure	29
4 User Interface Symbols – Parameter and Softkey Symbols	8	9.2 Evaluation Procedure	29
5 Internal Database	9	9.3 Sample Test Sequence	30
5.1 Creation of Test Structures	9	10 Measurement Parameters for Individual Measurements and Test Sequences	33
5.2 Export – Transmission and Storage of Test Structures and Measurement Data	9	11 Repair and Replacement Parts Service Calibration Center and Rental Instrument Service	34
5.3 Import (PRO and/or Feature KB01 only)	9	12 Product Support	34
6 Data Input	9	13 Database Software	35
6.1 Keyboard or Softkey Entries	9		
6.2 Entry via Touch Screen (SECUTEST PRO and/or Feature E01 only)	9		
7 Notes on Saving Single Measurements and Test Sequences	10		
8 Single Measurements	11		
8.1 RPE – Protective Conductor Resistance for Protection Class I Devices	12		
8.2 RISO – Insulation Resistance Measurement for Protection Class I Devices	13		
8.3 RISO – Insulation Resistance Measurement for Protection Class II Devices	14		
8.4 IPE – Protective Conductor Current	15		
8.5 IB – Touch Current	16		
8.6 IG – Device Leakage Current	17		
8.7 IA – Leakage Current from the Application Part	18		
8.8 IP – Patient Leakage Current	19		
8.9 U – Probe Voltage	20		
8.10 U – Measuring Voltage	21		
8.11 tA – PRCD Time to Trip (portable residual current device)	22		
8.12 P – Functions Test	23		
8.13 EL1 – Function Testing of Extension Cords	24		

1 Safety Precautions

SECUTEST BASE(10), SECUTEST PRO and SECULIFE ST BASE(25) test instruments are manufactured and tested in accordance with the following safety regulations:

IEC/EN 61010-1 / VDE 0411-1, DIN VDE 0404, IEC/EN 61577 / VDE 0413-2, -4 / DIN EN 61557-16 / VDE 0413-16

The safety of the user, the test instrument and the device under test (electrical equipment or electrical medical device) is only assured when the instrument is used for its intended purpose.

Read these condensed operating instructions and the full operating instructions carefully and completely before placing your test instrument into service (available at our homepage www.gossenmetrawatt.com for download). Follow all instructions contained therein. Make sure that the operating instructions are available to all users of the instrument.

Tests may only be performed by a qualified electrician, or under the supervision and direction of a qualified electrician. The user must be instructed by a qualified electrician concerning performance and evaluation of the test.

Suitable personal safety equipment is required.

If you use any active or passive implanted medical devices, please consult your doctor or the manufacturer of these devices.



Note!

Manufacturers and importers of electrical medical devices must provide documentation for the performance of maintenance by trained personnel.

Observe the following safety precautions:

- The instrument may only be connected to electrical systems (TN, TT or IT) with a maximum of 240 V which complies with applicable safety regulations (e.g. IEC 60346, VDE 0100) and is protected with a fuse or circuit breaker with a maximum rating of 16 A.
- Measurements within electrical systems are prohibited.

- Be prepared for the occurrence of unexpected voltages at devices under test (for example, capacitors can be dangerously charged).
- Make certain that the measurement cables are in flawless condition, e.g. no damage to insulation, no cracks in cables or plugs etc.
- When using a test probe with coil cord (SK2W):
Grip the tip of the test probe firmly, for example during insertion into a jack socket. Tensioning at the coil cord may otherwise cause the test probe to snap back resulting in possible injury.
- **Measurement of insulation resistance and equivalent leakage current (leakage current alternative measuring methods)**
Testing is conducted with up to 500 V. Current limiting is utilized ($I < 3.5$ mA), but if terminals L or N at the test socket are touched, electrical shock may occur which could result in consequential accidents.
- **Leakage current measurement during operation with line voltage:** Please note that the device under test is operated with line voltage during measurement. Exposed conductive parts may conduct dangerous touch voltage during testing. Do not touch under any circumstances! (Mains power is disconnected if leakage current exceeds approx. 10 mA.)



Attention!

The function test may only be performed after the DUT has successfully passed the safety test!

- **Probe check for probe connector P1:** Please perform a probe check after each test.



Attention!

If there is a fuse defect in test probe P1 after having started the test, all subsequent measurements which are performed with this measurement path might be erroneously rated as good!

Fuse replacement

The fuses may only be replaced when the instrument is voltage-free, i.e. the instrument must be disconnected from mains supply power and may not be connected to a measuring circuit. The fuse type must comply with the specifications in the technical data or the labeling on the instrument.

Opening the instrument / repairs

The instrument may only be opened by authorized, trained personnel in order to ensure flawless operation and to assure that the guarantee is not rendered null and void. Even original replacement parts may only be installed by authorized, trained personnel. If it can be ascertained that the instrument has been opened by unauthorized personnel, no guarantee claims can be honored by the manufacturer with regard to personal safety, measuring accuracy, compliance with applicable safety measures or any consequential damages.

Any warranty claims will be forfeited when the warranty seal has been damaged or removed.

Switching power consumers (max. 16 A*)

Be absolutely sure to adhere to the sequence specified below when switching the live device under test. This prevents excessive wear of the mains relays at the test instrument.

Before measurement:

- 1) **DUT:** Turn the DUT off via its own switch.
- 2) **Tester:** Switch line voltage to the test socket.
- 3) **DUT:** Turn the DUT on via its own switch.

After measurement:

- 4) **DUT:** Turn the DUT off via its own switch.
- 5) **Tester:** Deactivate line voltage to the test socket.

* for currents > 16 A AC please use adapter AT3-IIS32 (Z745X), for example

The test instrument may not be used:

- If external damage is apparent, for example if parts which conduct dangerous touch voltage are freely accessible, if the display is broken or defective (in which case dangerous voltage or mains connection errors might no longer be indicated)
- If the seal or sealing lacquer has been removed as the result of repairs or manipulation carried out by a non-authorized/non-certified service provider.
- With damaged connection and/or measurement cables and patient ports, e.g. interrupted insulation or kinked cable
- If the instrument no longer functions flawlessly
- After serious damage due to transport

In such cases, the instrument must be removed from operation and secured against unintentional use.

Meanings of Symbols on the Instrument

The symbols on the instrument have the following meanings:



Warning regarding dangerous electrical voltage



Warning concerning a point of danger (attention: observe documentation!)



Indicates European Conformity



This device may not be disposed of with the trash. Further information regarding the WEEE mark can be accessed on the Internet at www.gossenmetrawatt.com by entering the search term "WEEE".



If the guarantee seal is damaged or removed, all guarantee claims are rendered null and void.

QR CODE

QR CODE is a registered trademark of DENSO WAVE INCORPORATED

2 Initial Start-Up

2.1 Mains Connection

Nominal mains values: 100 to 240 V, 50 Hz to 400 Hz

- ➔ Connect the test instrument to the mains cable via its inlet plug and insert the mains plug into an electrical outlet. The function selector switch can be set to any position. If a mains outlet (earthing contact outlet) is not available, or if only a 3-phase outlet is available, the adapter socket can be used to connect the phase conductor, the neutral conductor and the protective conductor. The adapter socket has three permanently attached cables and is included with the KS13 cable set (see wiring diagram in the operating instructions).



Attention!

If connection is not possible via an earthing contact outlet: Shut down mains power first. Then connect the cables from the coupling socket to the mains using pick-off clips in accordance with the diagram. Disconnection from mains power is only possible with the mains plug.

Measurements in IT Systems (as from FW 1.5.0)

The setting **IT system** can be activated in selector switch position **SETUP** (Setup 1/3) under sub-menu **All Measurement**:

Parameter „Meas. at IT-mains“ = **Yes**: active leakage current measurements (and/or all measurements which include the PE at the mains connection end) are blocked. Test sequences which contain such kind of measurements are disabled as well.

2.2 Detection of Mains Connection Errors

The device automatically recognizes mains connection errors if the conditions in the following table have been fulfilled. The user is informed of the type of error, and all measuring functions are disabled in the event of danger.

Type of Connection Error	Message	Condition	Measurements
Voltage at protective conductor PE to finger contact (START/STOP key)	Display at the instrument	Press START/STOP button $U > 25 \text{ V}$ Button \rightarrow PE: $< 1 \text{ M}\Omega^2$	All measurements disabled
Protective conductor PE & phase conductor L reversed and/or neutral conductor N interrupted		Voltage at PE $> 100 \text{ V}$	Impossible (no supply power)
Line voltage $< 180 \text{ V} / < 90 \text{ V}$ (depending on mains)		$U_{L-N} < 180 \text{ V}$ $U_{L-N} < 90 \text{ V}$	Possible under certain circumstances ¹
Test on IT/TN system	Display at the instrument	Connection N \rightarrow PE $> 20 \text{ k}\Omega$	Possible under certain circumstances

¹ 10 A/25 A R_{PE} measurements are only possible with line voltages of 115/230 V and line frequencies of 50/60 Hz.

² if the test person is highly insulated, the following error message may appear: „Interference voltage at PE of mains connection“



Attention!

In the event of mains connection errors as described in either of the first two cases in the table above, immediately disconnect the test instrument from the mains and arrange to have the error eliminated!



Note!

Voltage at the electrical system's protective conductor PE may result in distorted measurement values during testing for the absence of voltage, or during leakage voltage measurements.

3 Overview of Functions Included with SECUTEST BASE(10)/PRO and SECULIFE ST BASE Testers

Switch setting, description as of	Measuring functions, test current/voltage
Single measurements, rotary switch level: green	
Measurements at voltage-free objects	
Page 12	R_{PE} R _{PE} protect. conductor resistance I _p test current (200 mA) SECUTEST BASE10/PRO SECULIFE ST BASE: 10 A¹ (Feature G01) SECULIFE ST BASE25: 25 A¹⁾ (Feature G02)
	R_{ISO} R _{INS} insulation resistance U _{INS} test voltage
Measurements at DUTs with line voltage	
Page 15	I_{PE} I _{PE} ≅ prot. conductor current, TRMS I _{PE} ~ AC component I _{PE} = DC component U _{LPE} test voltage U _{Gen} reference voltage (alternative)
	I_B I _T ≅ touch voltage, TRMS I _T ~ AC component I _T = DC component U _{LPE} test voltage U _{Gen} reference voltage (alternative)
	I_G I _E ≅ device leakage current, TRMS I _E ~ AC component I _E = DC component U _{LPE} test voltage U _{Gen} reference voltage (alternative)
	I_A I _A ≅ leakage current from app. part U _A test voltage U _{Gen} reference voltage (alternative)
	I_P I _P ≅ patient leakage current, TRMS I _P ~ AC component I _P = DC component U _{LPE} test voltage
Page 20	U U≅ probe voltage, TRMS U~ alt. voltage component U= direct voltage component U≅ RMS Voltage² U~ AC voltage component ² U= DC voltage component ²
	t_A³ t _B time to trip for 10/30 mA PRCD U _{LN} line voltage at the test socket

Switch setting, description as of	Measuring functions, test current/voltage	
Page 23	P Function test at the test socket I current between L and N U voltage between L and N f frequency P active power S apparent power PF power factor	
	Probe measuring functions	
	Page 24	EL1 Extension cord function test with EL1/VL2E/AT3-IIIIE adapter: continuity, short-circuit, reversed wires ⁴
	Page 25	EXTRA Reserved for expansions in connection with software updates °C Temperature measurement ² with Pt100/Pt1000 IZ Measurement of current at clamp with current clamp sensor
		Test sequences per standard rotary switch level: orange
	Page 29	
Preconfigured (freely selectable) test sequences		
A1	VDE 0701-0702 , passive measuring method, test socket	
A2	VDE 0701-0702 , active measurement type, test socket	
A3	VDE 0701-0702 , parameters configuration for EDP (active)	
A4	IEC 62353 (VDE 0751) , passive measurement type	
A5	IEC 62353 (VDE 0751) , active measurement type	
A6	IEC 60974-4 , connection type: test socket	
A7	IEC 60974-4 , connection type: AT16-DI/AT32-DI	
A8	VDE 0701-0702 , measurement type Extension Cord test (RPE, RiSO), EL1/VL2E/AT3-IIIIE adapter	
AUTO	Freely selectable standard, connection type and measurement type	

¹ 10 A/25 A-R_{PE} measurements are only possible with line voltages of 115 V/230 V and line frequencies of 50 Hz/60 Hz.
² Voltage measuring inputs only for **SECUTEST PRO** (or for devices with feature I01) and **SECULIFE ST BASE(25)**
³ Measurement of time to trip not possible in IT systems.
⁴ No checking for reversed polarity takes place when the EL1 adapter is used.



Note!

Changes in test sequences A1 ... A8 and AUTO are preserved even after switching off the test instrument.

4 User Interface Symbols – Parameter and Softkey Symbols

Symbols	Setup Page	Parameters and their significance
		<i>Complete overviews of all symbols are included in the full operating instructions.</i>
	1/3	All measurements: Ref.voltage L-PE: voltage to which the measured values for leakage current have been standardized; Gnd fault sens.: continuous residual current monitoring (10/30 mA)
		Automatic measurements: set parameters for test sequences: start and end view, inclusive operation uncertainty (yes/no), auto measurement point (yes/no)
	1/3	Database: deletion, statistics, with inserted USB stick : save, restore database
	1/3	System: set general device parameters; date/time, volume, brightness, default settings, self-test
	2/3	Printer: printer selection for USB master interface connected, disconnected
	2/3	Tester: select tester from list, add new tester
	2/3	Culture: select language for operating instructions, keyboard and measuring sequences by acknowledging the respective national flag; Reboot necessary!
	2/3	Optionally connected external devices USB stick, keyboard / barcode scanner, printer
	3/3	System information: query software and hardware version, serial number, build number, calibration data and storage occupancy
	—	Functions and their significance
		Set classification parameters for the respective test sequence (test sequences: switch settings AUTO, A1 ... A8)
		Accept parameters, acknowledge message
		Abort single measurement or test sequence
		Evaluate measurement of visual inspection with OK or not OK (toggle key)
		Continue test, next test step in the test sequence
		Symbol left: Direct selection key measurement type (connection type...) or measuring method (direct ...) / Symbol right: Selection between two states (no submenu)
		Start evaluation – record measured value. Each time this softkey is pressed, an additional measured value is saved and the number is increased by one.
		Symbol left: Repeat measured value recording Symbol right: Repeat test step in the test sequence
		Symbol left: Delete measured value Symbol right: Skip individual tests in the test sequence
		Display measured values from performed measurements and test sequences
		Magnifying glass symbol: show (+) or hide (–) details regarding database objects or selected measurements
		Enter a new ID for a test object either before or after a test, and in case the ID has not yet been entered to the structure
		Save measurement data / save measurement data as (with display of directory path / ID or new entry of an ID other than the preselected one)

5 Internal Database

5.1 Creation of Test Structures

A complete test structure with data regarding customers and devices under test be created in the test instrument. This structure makes it possible to store the results of single measurements or test sequences of test objects belonging to various customers. Manual single measurements can be grouped together into a so-called “manual sequence”.

A complete description of database creation is included in the full operating instructions for your test instrument.

5.2 Export – Transmission and Storage of Test Structures and Measurement Data

Structures set up in, and measurement data saved to the test instrument can be imported to the **IZYTRONIQ** report generating software via a plugged-in USB stick (PRO and/or Feature KB01 only) or via the USB slave port. Data can then be saved to the PC and reports can be generated.



Note!

Data transfer to **IZYTRONIQ** should not be started during single measurements or test sequences.

Furthermore, you can save the database to a plugged-in USB stick for subsequent restoring to the device memory.

5.3 Import (PRO and/or Feature KB01 only)

The test structures created at the PC with the help of the report generating software can be loaded into the test instrument via an USB stick or via the USB slave port.

6 Data Input

6.1 Keyboard or Softkey Entries

After selecting **ID** or any other object parameter, a keyboard is displayed which allows for the entry of alphanumeric characters via the fixed function keys and the softkeys. Alternatively, entries can also be made with the help of a USB keyboard or barcode scanner which is connected to the instrument.

Procedure

(example: entering a DUT designation)

- 1 Switch the keyboard to uppercase, lowercase or special characters with the abc key (Abc, ABC, Symb).
- 2 Select the desired alphanumeric character or a line break with the scroll keys (left, right, up and down).
The selection cursor can be accelerated by pressing and holding the respective scroll key.
- 3 After pressing the key, the respective character appears in the display field.
- 4 Repeat steps 1 through 3 until the complete designation is shown in the display field.
- 5 After pressing the green checkmark , the selected character string is saved.

6.2 Entry via Touch Screen (SECUTEST PRO and/or Feature E01 only)

The touch-screen allows for the convenient entry of data and comments, parameters and direct parameter selection.

Example Softkey Entries



Switch between key and display field				Delete characters from right
Exit entry function without saving				Toggle: uppercase, lowercase, special char.
Scroll up				Scroll right
Scroll down				Scroll left
Transfer char. at cursor position to display field				Accept entry

7 Notes on Saving Single Measurements and Test Sequences

At the end of each test, test results can be saved under an ID number which is unequivocally assigned to the respective test object. Depending on the initial situation, i.e. whether or not a test structure or database is already available or an ID has already been entered, the following different procedures are used for saving:



Variant 1 – pre-selection of an existing ID

You've already set up a test structure in the test instrument or loaded one from the **IZYTRONIQ**.

Open the database view before starting the measurement by pressing the **MEM** key. Then select the test object or its ID within the test structure by pressing the respective scroll key. Exit the database view (MEM navigation) by pressing **ESC** and start the measurement. Press the **Save as**  key at the end of the measurement. The display is switched to the **SAVE** view. The ID appears with a green or orange background. Press the **Save**  key in order to complete the procedure.

Variant 2 – entry of an existing ID at the end of the test

You've already set up a test structure in the test instrument or loaded one from the **IZYTRONIQ (SECUTEST PRO only)**. You perform the measurement without first opening the database. No test object was previously selected in the database. Press the **Save as**  key at the end of the measurement. The following message appears: "No DUT selected!" Press the **ID** key. The softkey keyboard appears.









If you enter an ID here which is already in the database, the database view appears automatically (MEM navigation) and the test object's ID is displayed inversely. Acknowledge the entry by pressing the  key. The display is switched to the **SAVE** view. The ID appears with a green or orange background. Press the **Save**  key once again in order to complete the procedure.

Variant 3 – entry of a new ID at the end of the test

You haven't yet set up a test structure in the test instrument, or the ID is not included in the existing structure.

Press the **Save as**  key at the end of the measurement. The following message appears: "No DUT selected!" Press the **ID** key in order to enter the test object's ID. The softkey keyboard appears.

If you enter an ID here which is **not yet** included in the database, a prompt appears asking you if you want to enter a new object.









- : If you press , the display is switched to the **SAYVE** view. The ID appears with a green background. Press the  key once again in order to complete the procedure.
- : If you press , the database view appears (MEM navigation). Go to the next page (**Process objects 2/3**) by pressing , and then enter a new test object. Press  to this end. All possible object types are displayed. Press "DUT". The newly entered ID appears in red to the right of the ID parameter. Acknowledge the entry by pressing the  key. The display is switched to the database view (MEM navigation). The newly entered test object is displayed inversely in the structure. Press **ESC** in order to return to the **SAVE** view. The ID appears with a green or orange background. Press the  key once again in order to complete the procedure.
- **ESC**: If you don't want to save any measured values, press **ESC** twice in order to go to the measuring view. If you press **ESC** again, a prompt appears asking whether or not you want to delete the measuring points in order to continue with the measurement without saving.

8 Single Measurements

Any measuring duration is possible. The respective measurement is ended by pressing **START/STOP**. No limit values have been entered for single measurements. As a result, no evaluation of the measurement results takes place.

Procedure for measuring with save function and pre-selection of the (ME) device

If you'd like to save your single measurements to selected (ME) devices in a database (see section 5), the following procedure is advisable.

- 1 Activate the database view (MEM navigation) by pressing the **MEM** key. 
- 2 Select the (ME) device or its ID number for the following measurements with the scroll keys. 
- 3 Return to the measuring view by pressing the **ESC** key or the **START/STOP** key. 
- 4 Start the test with the **START/STOP** key before switching the DUT on. The measured value recording symbol shown at the right appears. Each time this key is pressed, the currently displayed value is saved to the clipboard and the number shown in the symbol is increased by one. 

- 5 Switch off the DUT before finishing the test with the **START/STOP** key. The **Save as** symbol appears (floppy disk icon with the number of measured values saved to the clipboard). 

- 6 If you press the save symbol now, the display is switched to the **SAVE** view, where the pre-selected (ME) device is highlighted. 
- 7 After pressing the **Save** symbol once again, acknowledgement of successful storage appears. At the same time, the display returns to the measuring view. 

Procedure for measuring with save function and subsequent entry of the (ME) device

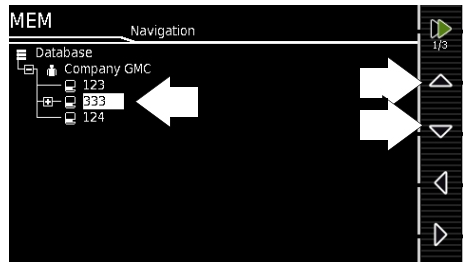
As an alternative to the procedure described above, you can start with step 4 and, after measurement has been completed, assign the results to a (ME) device or its ID number which is included in the database: manually by selecting **ID** and entering the ID via the alphanumeric keyboard, or by scanning a barcode.

Select DUT



Start → stop → initiate saving

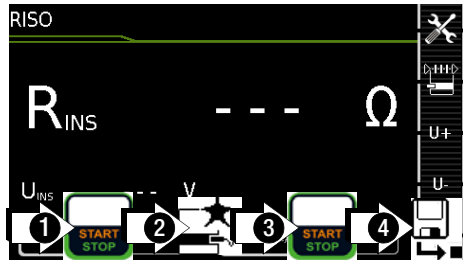

Check → end saving

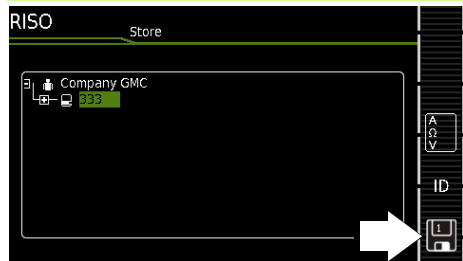

8.1 RPE – Protective Conductor Resistance for Protection Class I Devices

1 Select measuring function



2 Select parameters



3 Set parameters

Meas. Parameter	Meaning
Mode (Measurement type) admissible test current IP	
passive: PE(TS) – P1 @ IP = 200 mA/10 A	Testing between the 2 protective conductor terminals: at test socket ⁴ and test probe P1
active: PE(PD) – P1 @ IP = 200 mA/25 A	Like PE(TS) – P1 but with mains voltage to socket and with continuously increasing DC current (PRCDs)
PE(mains) – P1 <i>Permanently connected devices</i> @ IP = 200 mA/10 A	Testing between ground terminal at mains and test probe P1
PE(Mains) – P1 clip	@ IP = 10 A, see section 8.16
P1 – P2 @ IP = 200 mA/10 A/25 A	Only test devices with feature H01: 2-pole measurement between test probe 1 and 2, see section 8.15
IP(set) Ip	
200 mA	Test cur.: 200 mA AC (+/-/± DC)
10 A ¹	Test current: 10 A (Feature G01)
25 A ²	Test current: 10 A (Feature G02)
f – only at 200 mA ~ (AC)	
50 to 200 Hz	Test sequence (adjustable in increments)
Offset	
> 0 to < 2 Ω ³	Zero balancing for selected ref. point.

- ¹ SECUTEST BASE10 / SECUTEST PRO / SECULIFE ST BASE
- ² SECULIFE ST BASE25
- ³ The selected offset value is permanently stored to memory and adapted for measurements in selector switch position AUTO.
- ⁴ Connection also via EL1, VL2E, AT3 adapter, AT16DI/AT32DI

4 Connect DUT

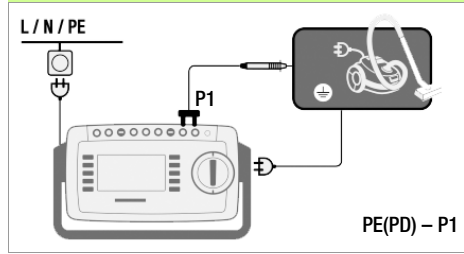

- ⇒ Connect the DUT to the test socket.
- ⇒ Contact all conductive parts which are connected to the protective conductor with test probe P1.

Special case: permanently installed DUT

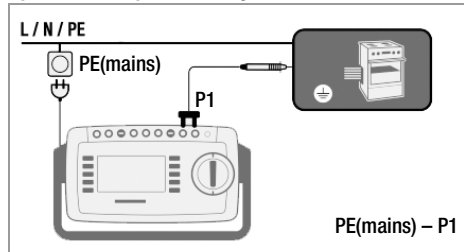

- ⇒ Contact all conductive housing parts with test probe P1.

5 Start test



6 Acknowledge line voltage warning

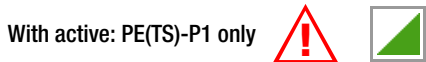

With active: PE(TS)-P1 only

6 Save measured values to clipboard



7 Stop test



8 Save measurements under ID no.

8.2 RISO – Insulation Resistance Measurement for Protection Class I Devices

1 Select measuring function



RISO

2 Select parameters

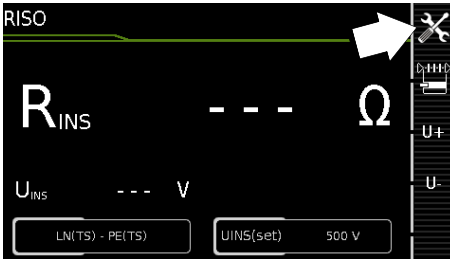

U+/U- = increase/decrease UINS(set)

3 Set parameters

Meas. Parameter	Meaning
Mode (Measurement type)	
LN(TS) – PE(TS)	PC I: Testing between short-circuited LN mains terminals at test socket and the DUT's PE terminal ¹
LN(TS) – P1	See section 8.3
P1 – P2	Only test devices with feature H01: 2-pole measurement between test probe 1 and 2 instead of test socket connection
PE(mains) – P1 <i>Permanently connected devices</i>	Cable test: Testing between ground terminal at mains and test probe P1
PE(TS) – P1	Testing between PE terminal at test socket and test probe P1
LN(TS) – P1//PE(TS)	Testing between short-circuited LN mains terminals at test socket and test probe P1, including PE at test socket
UINS(set)	U+/U-
> 50 to < 500 V	Variable test voltage can be entered with the numeric keypad

¹ Connection also via EL1, VL2E, AT3-IIIIE, AT3-IIS, AT3-II S32, AT16DI/AT32DI or CEE adapter

4 Connect DUT

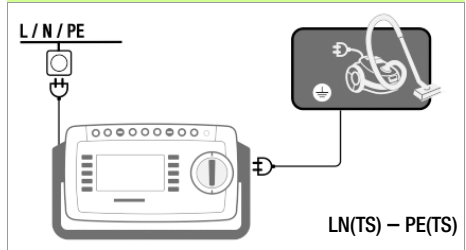

Special case: inputs for application parts

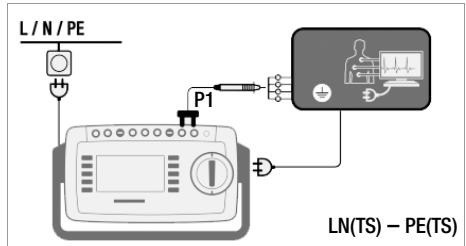

- Connect the DUT to the test socket.
- Contact the short-circuited inputs for the application parts with test probe P1.

5 Start test



6 Save measured values to clipboard



7 Stop test



8 Save measurements under ID no.

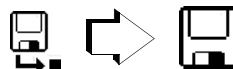

8.3 RISO – Insulation Resistance Measurement for Protection Class II Devices

1 Select measuring function



RISO

2 Select parameters

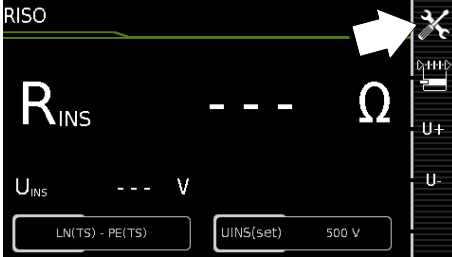

U+ = increase UINS(set)
 U- = decrease UINS(set)

3 Set parameters

Meas. Parameter	Meaning
Mode (Measurement type)	
LN(TS) – P1	Testing between short-circuited LN mains terminals at test socket and test probe P1 (Connection via test socket, via adapter VL2E, AT3-III E, AT3-IIS, AT3-II S32 or AT16DI/AT32DI)
UINS(set)	U+ / U-
> 50 to < 500 V	Variable test voltage can be entered with the numeric keypad

4 Connect DUT

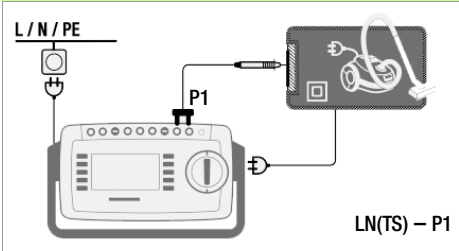

- Connect the DUT to the test socket.
- Contact all conductive, exposed parts with test probe P1.

5 Start test



6 Save measured values to clipboard



7 Stop test



8 Save measurements under ID no.

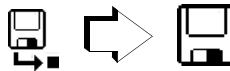

8.4 IPE – Protective Conductor Current

1 Select Measuring Function



2 Select parameters

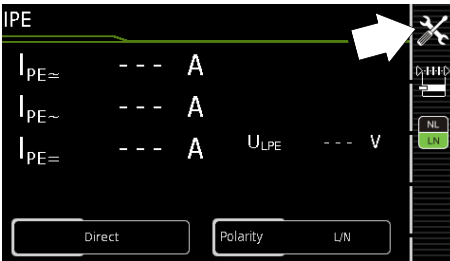

3 Set parameters

Meas. Parameter	Meaning
Mode (Measurement type)	
Direct	Direct measuring method (via test socket, AT16DI/AT32DI)
Differential	Differential current measurement (via test socket)
Alternative	Equivalent leakage current measuring method (via test socket ¹)
AT3 Adapter	Only test devices with feature IO1: Measurement with adapter AT3-III E, AT3-IIS or AT3-II S32 See section 8.17
Clip	Only test devices with feature IO1: See section 8.16
Polarity – for direct and differential only	
L/N or N/L	Selection of polarity for line voltage at test socket

¹ Connection also via VL2E, AT3 adapter, AT16DI/AT32DI

Prior to all leakage current measurements, please make sure that the measurement parameters „Ref. voltage L-PE“ and „Testingfreq. Alt“ have been correctly set in the SETUP, see section 10.

4 Connect DUT

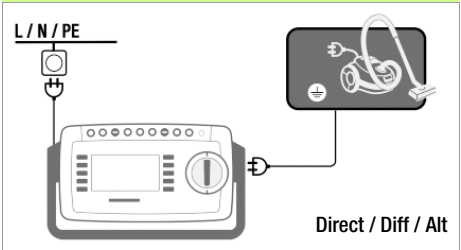

⇒ Connect the DUT (to test socket).

5 Start test



6 Acknowledge line voltage warning

Direct & differential & AT3 Adapter:



⇒ Switch DUT on

7 Save measured values to clipboard



⇒ Switch DUT off

8 Stop test



9 Save measurements under ID no.

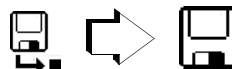

8.5 IB – Touch Current

1 Select measuring function



2 Select parameters

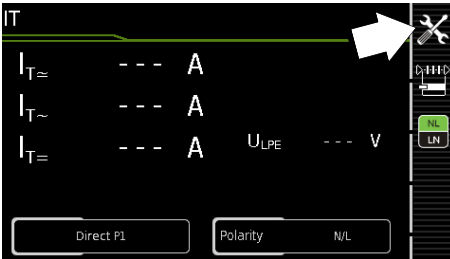

3 Set parameters

Meas. Parameter	Meaning
Mode (Measurement type)	
Direct P1	Direct measuring method (via test socket ¹)
Differential P1	Differential current measurement (via test socket)
Alternative P1	Equivalent leakage current measuring method (via test socket ¹ or VL2E)
Permanent connection P1	Permanently connected DUT
Alternative P1–P2	Only test devices with feature H01: Equivalent leakage current measurement method: 2-pole measurement between test probe 1 and 2, see section 8.15
Polarity – for direct and differential only	
L/N or N/L	Selection of polarity for line voltage at test socket

¹ Connection also via AT3-III E, AT3-II S, AT3-II S32, AT16DI/AT32DI

Prior to all leakage current measurements, please make sure that the measurement parameters „Ref. voltage L-PE“ and „Testingfreq. Alt“ have been correctly set in the SETUP, see section 10.

4 Connect DUT

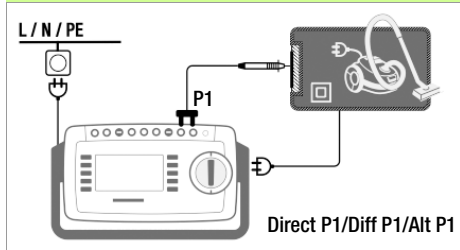

- Connect the DUT to the test socket.
- Contact additional, accessible, conductive parts which are not connected to the protective conductor with test probe P1.

5 Start test



6 Acknowledge line voltage warning

Direct & differential:



7 Save measured values to clipboard



8 Stop test



9 Save measurements under ID no.

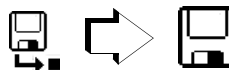

8.6 IG – Device Leakage Current

1 Select measuring function



2 Select parameters

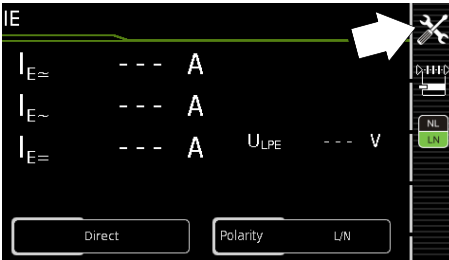

3 Set parameters

Meas. Parameter	Meaning
Mode (Measurement type)	
Direct	Direct measuring method (via test socket ¹), optional probe contact
Differential	Differential current measurement (via test socket)
Alternative	Equivalent leakage current measuring method with probe contact (via test socket, AT16DI/AT32DI)
AT3 adapter	Only test devices with feature IO1: Measurement with adapter AT3-IIIE, AT3-IIS or AT3-II S32 See section 8.17
Clamp	Only test devices with feature IO1: see section 8.16
Polarity – for Direct, Differential and AT3-adapter only	
L/N or N/L	Selection of polarity for line voltage at test socket

¹ Connection also via AT16DI/AT32DI (only differential current method useful)

Prior to all leakage current measurements, please make sure that the measurement parameters „Ref. voltage L-PE“ and „Testingfreq. Alt“ have been correctly set in the SETUP, see section 10.

4 Connect DUT

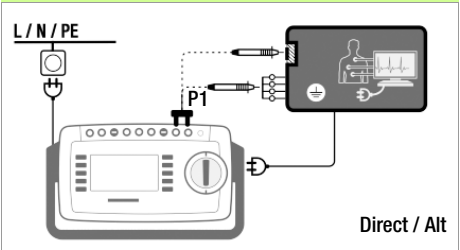

- ✦ Connect the DUT to the test socket.
- ✦ Contact accessible, conductive parts which are not connected to the protective conductor with test probe P1.
- ✦ For DUTs with application parts: additionally contact the short-circuited inputs for the application parts with test probe P1.

5 Start test



6 Acknowledge line voltage warning

Direct & differential & AT3 Adapter:

7 Save measured values to clipboard



8 Stop test



9 Save measurements under ID no.

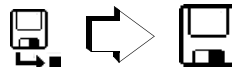

8.7 IA – Leakage Current from the Application Part

1 Select measuring function



2 Select parameters

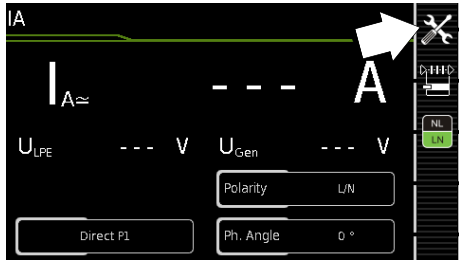

3 Set parameters

Meas. Parameter	Meaning
Mode (Measurement type)	
Direct P1	Direct measuring method (via test socket) with test probe P1
Alternative P1	Equivalent leakage current measuring method (via test socket) with test probe P1
Permanent connection P1	Permanently connected DUT
Phase Angle – for Direct (P1) and Perm. c. only	
0° or 180°	Selectable phase angle of the internal generator in relation to mains phase angle
Polarity – for Direct (P1) only	
L/N or N/L	Selection of polarity for line voltage at test socket

4 Connect DUT

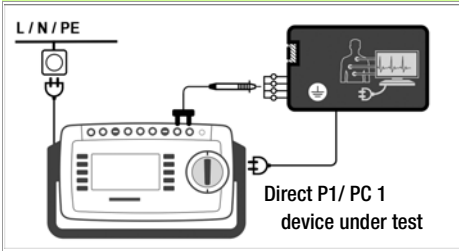

- Connect the DUT (to test socket).
- Contact the short-circuited inputs for the application parts with test probe P1.

5 Start test



6 Acknowledge line voltage warning



6 Save measured values to clipboard



7 Stop test



9 Save measurements under ID no.

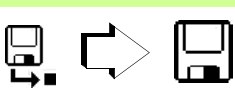

Prior to all leakage current measurements, please make sure that the measurement parameters „Ref. voltage L-PE“ and „Testingfreq. Alt“ have been correctly set in the SETUP, see section 10.

8.8 IP – Patient Leakage Current

1 Select measuring function



2 Select parameters

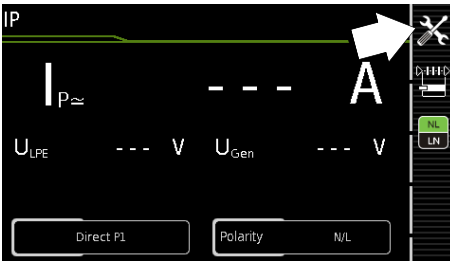

3 Set parameters

Meas. Parameter	Meaning
Mode (Measurement type)	
Direct P1	Direct measuring method (via test socket) with test probe P1
Permanent connection P1	Permanently connected DUT
Polarity	
L/N or N/L	Selection of polarity for line voltage at test socket

Prior to all leakage current measurements, please make sure that the measurement parameters „Ref. voltage L-PE“ and „Testingfreq. Alt.“ have been correctly set in the SETUP, see section 10.

4 Connect DUT

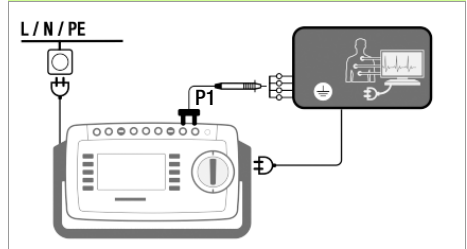

- Connect the DUT to the test socket.
- Contact the short-circuited inputs for the application parts with test probe P1.

5 Start test



6 Acknowledge line voltage warning



7 Save measured values to clipboard



8 Stop test



9 Save measurements under ID no.

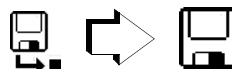

8.9 U – Probe Voltage

1 Select measuring function



2 Select parameters



3 Set parameters

Meas. Parameter	Meaning
Mode (Measurement type)	
PE – P1	Measurement of voltages with reference to PE, test socket remains voltage-free, e.g. for permanently connected DUTs
PE – P1 (with mains)	Measurement of voltages with reference to PE, line voltage is applied to the test socket
L/N or N/L	Selection of polarity for line voltage at test socket (with „PE – P1 (with mains)“ only)

4 Connect DUT

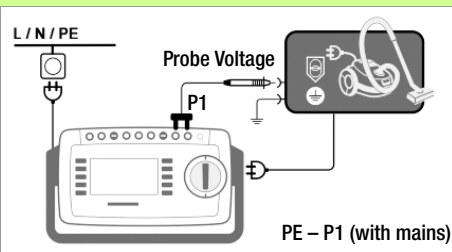

- ⇨ Connect the DUT to the test socket.
- ⇨ Contact the ungrounded output for protective extra-low voltage with test probe P1.
- ⇨ Select line voltage polarity.

Special case: permanently installed DUT

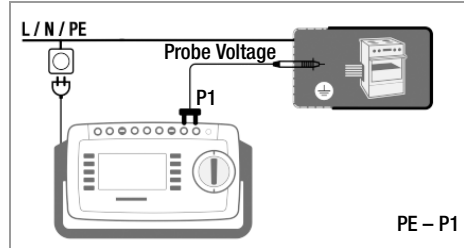

- ⇨ Contact all voltage conducting parts with test probe P1.

5 Start test



6 Acknowledge line voltage warning

Only for measurement type: (with mains)



7 Save measured values to clipboard



8 Stop test



9 Save measurements under ID no.

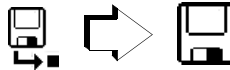

8.10 U – Measuring Voltage

SECUTEST PRO and SECULIFE ST BASE only:

1 Select measuring function



2 Select parameters

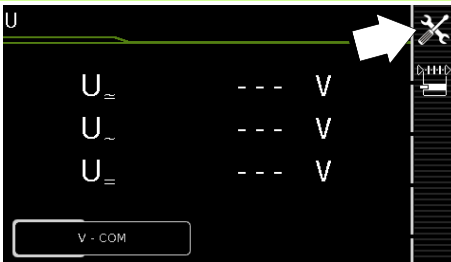

3 Set parameters

Meas. Parameter	Meaning
Mode (Measurement type)	
V – COM	Effective value + AC + DC for permanently connected DUTs
V – COM (with mains)	Effective value + AC + DC; for line voltage at test socket

4 Connect DUT

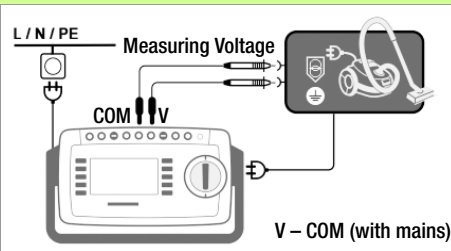

Attention! Only use the enclosed contact-protected KS17-ONE measurement cables for the measurement of dangerous voltages, please.

Special case: permanently installed DUT

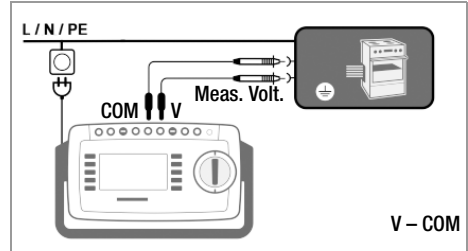



- For testing mains power packs and charging units: Connect the DUT mains terminal with the test socket.
- Connect the DUT output, e.g. for measuring safety extra low voltage (SELV), with sockets **V** and **COM**.

5 Start test



6 Acknowledge line voltage warning

Only for measurement type: (with mains)  

7 Save measured values to clipboard 

8 Stop test



9 Save measurements under ID no.

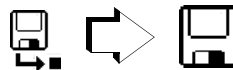

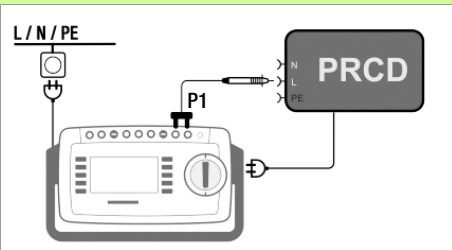
8.11 t_A – PRCD Time to Trip (portable residual current device)**1** Select Measuring Function**2****3** Connect DUT

⇨ Connect the PRCD to the test socket.

4 Start test (test current 30 mA)**5** Acknowledge line voltage warning**6** Execute test

- ⇨ Activate the PRCD.
- ⇨ Contact neutral conductor L at the PRCD with test probe P1 (if required, ascertain by trial and error).

The PRCD is tripped.

7 Testing is stopped automatically.

Ascertained time to trip is displayed.

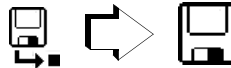
8 Save measurements under ID no.

8.12 P – Functions Test

1 Select measuring function



2 Select parameters

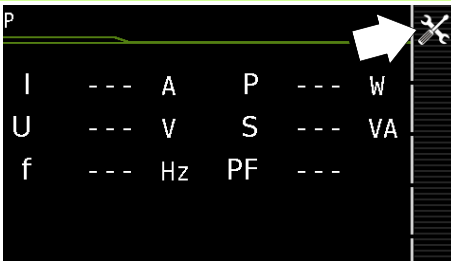

3 Set parameters

Meas. Parameter	Meaning
Polarity	
LN	Phase L – neutral conductor N
NL	Neutral conductor N – phase L

The following connection types are possible:

- Test socket
- CEE adapter (only for connection via single-phase CEE or „caravan socket“)
- AT3 adapter (AT3-IIIE, AT3-IIS, AT3-IIS32)
- AT16DI/AT32DI

 **Note!**

It is possible to use the adapters listed above for function testing (initial start-up of DUT). Apparent/active power, power factor and current consumption can only be measured, however, if the DUT is directly connected with the test socket or via the CEE adapter (single-phase CEE socket only).

4 Connect DUT

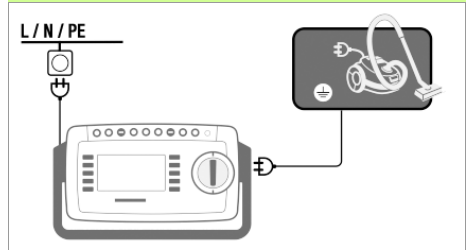

⇨ Connect the DUT to the test socket.

5 Starting test



6 Acknowledge line voltage warning



7 Save measured values to clipboard



8 Stop test



9 Save measurements under ID no.

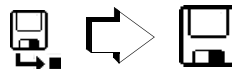

8.13 EL1 – Function Testing of Extension Cords

1 Select measuring function



2 Select parameters

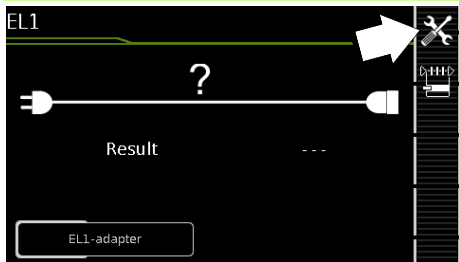

3 Set parameters

Meas. Parameter	Testing for			
	Measurement type	Continuity L(1/2/3), N	Short-circuit between L(1/2/3), N	Reversed polarity / Clockwise phase sequence
EL1 adapter		X	X	—
VL2E adapter		X	X	X
AT3-IIIE adapter		X	X	X

This function allows for the evaluation of the function of the active conductors L(1, 2, 3) and N of an extension cable. **The PE conductor is not being tested in this process!**

For the testing of R_{PE} and R_{INS} see respective single measurements.



Note!

See section 9, "Test Sequences in Accordance with Standards" (switch setting A8) with regard to testing extension cords per DIN VDE 0701-0702, for which R_{PE} and R_{INS} are measured.

4 Connect DUT

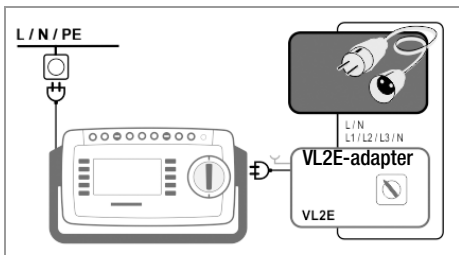
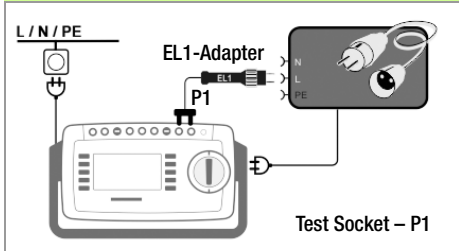

Connection of EL1 Adapter

- ✦ Connect the EL1 adapter to the P1 probe sockets at the test instrument.
- ✦ Connect the plug at the end of the extension cord to the test socket.
- ✦ Connect the coupling socket at the end of the extension cord to the plug at the EL1 adapter.

Connection of Test Adapters VL2E and AT3-IIIE

- ✦ Connection examples are shown in section 8.17.

5 Start test



Continuity test for L and N

6 Save measured values to clipboard



7 Stop test



9 Save measurements under ID no.

8.14 EXTRA – Special functions

SECUTEST BASE(10)

1 Select measuring function

EXTRA



SECUTEST PRO (Feature I01) & SECULIFE ST BASE(25)

1 Select measuring function

EXTRA



In this case, additional measurement functions are assigned to rotary switch position EXTRA.

2

Extra

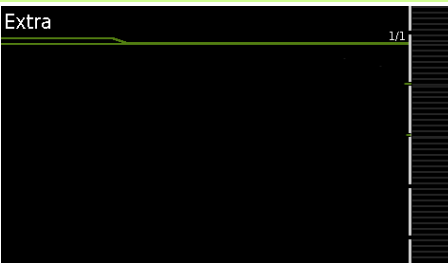

2 Temp. oder IZ

EXTRA

Measurements

temperature

Current (via clamp)

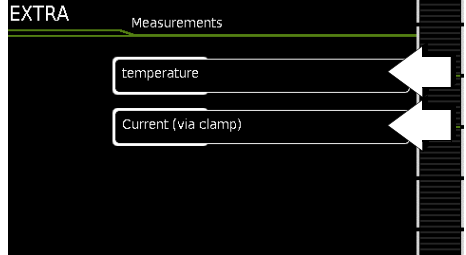

If a QR code is provided:
By scanning the code you can download the current operating instructions from our homepage www.gossenmetrawatt.com and read them with a tablet PC.

➤ Select the desired measuring function.

Temp. – Temperature measurement

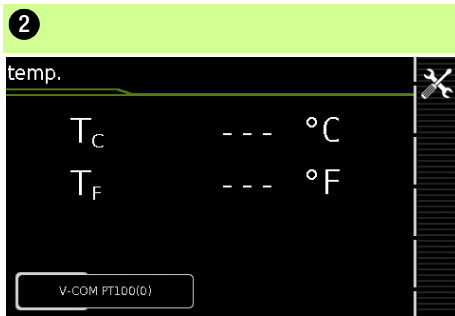

IZ – Current clamp measurement

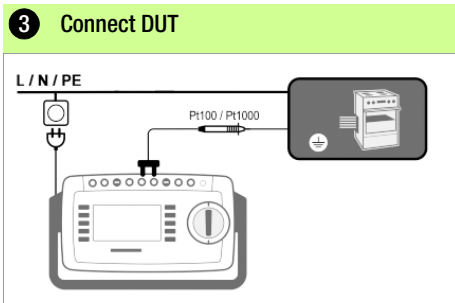
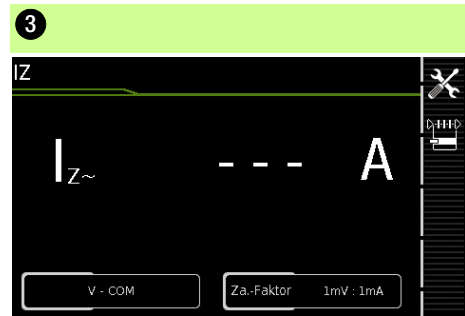

Temperature measurement works both with a Pt100 and a Pt1000 temperature sensor and automatically recognizes the utilized sensor type.

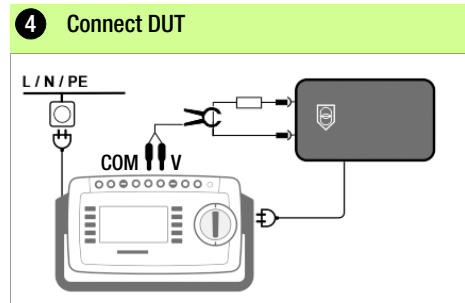
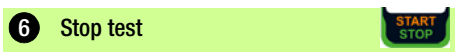
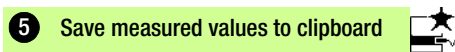
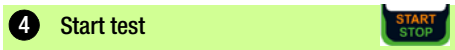

Meas. Parameter	Meaning
Measurement type	
V – COM	A AC for permanently connected DUTs
V – COM (with mains)	A AC; for line voltage at test socket
Polarity	
L/N or N/L	Selection of polarity for line voltage at test socket

- ↪ Adjust the clamp factor (cl. factor):
 - at the current clamp sensor
 - at the test instrument

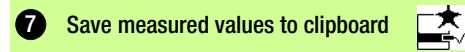
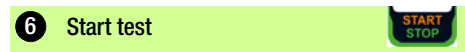

8.15 2-Pole Measurements with P1 and P2 Test Probes

SECUTEST PRO and SECULIFE ST BASE(25) only
 In case your DUT is not equipped with a country-specific mains plug that fits into the SECUTEST test socket or if it is a permanently installed DUT, the 2nd test probe, in combination with the 1st test probe, allows for 2-pole measurement (dual-lead measurement) of RPE, RINS and equivalent leakage current. Measurements with test probe 1 against test probe 2 (P1 – P2) are electrically isolated from the mains. There is no voltage present at the test probe.

Connection Example of RPE Measurement
 Measuring of protective conductor resistance RPE at permanently installed safety class I devices

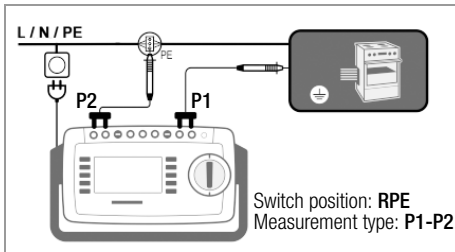

Connection Example of RISO or IB Measurements
 Measuring of insulation resistance RINS or touch current IB for safety class I devices

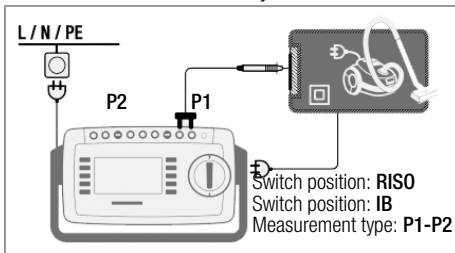

8.16 Measurement with Current Clamp Sensor at Permanently Installed DUTs of Safety Class I

SECUTEST PRO and SECULIFE ST BASE(25) only

SECUTEST PRO	Clamp		SECUTEST PRO
Parameter Transf. Ratio	Trans-former Ratio	Measuring Range	Display Range with Clamp
1 mV : 1 mA	WZ12C		0 mA ... 300 A
	1 mV : 1 mA	1 mA ... 15 A	

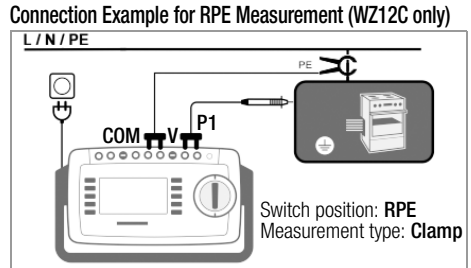

Measurement of test current by enclosing PE in the electric circuit. This type of measurement can only be selected if the test current has been set at 10 A AC.

Connection Example for IPE Measurement (Direct Measurement)

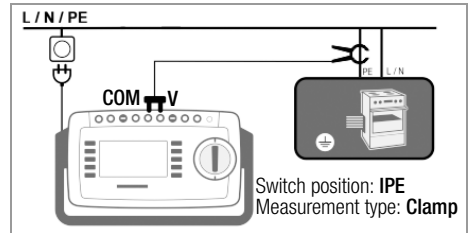

Measurement of protective conductor current by enclosing PE in the feeder.

Connection Example of IG Measurement (Difference Measurement)

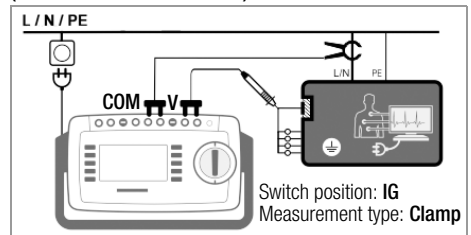

Measurement of device leakage current by enclosing conductors L and N in the feeder.

8.17 Measurements with Test Adapter

Test with Adapter	EL1	VL2E	AT3-III ²	AT16DI	CEE-Adapter
DUT terminals					
Inlet plug 1P+N+PE 16 A	—	✓	✓	—	—
Schuko 1P+N+PE 16 A	—	✓	—	—	—
CEE 1P+N+PE 16 A	—	✓	✓	—	✓
CEE 3P+N+PE 16 A	—	✓	✓	✓/—	✓
CEE 3P+N+PE 32 A	—	✓	✓	—/✓	✓
5 x 4 mm sockets	—	—	—	—	✓
Test instrument terminals					
Schuko 1P+N+PE 16 A	—	—	✓	✓	—
Socket for test probe	—	✓	✓	—	—
Plug for V-COM ¹	—	—	✓	—	—
Active Testing					
Protective conductor current IPE					
– Direct method	—	—	✓	✓	—
– Differential current	—	—	✓ ¹	✓	—
Device leakage current IG					
– Direct method	—	—	✓	✓	—
– Differential current	—	—	✓ ¹	✓	—
Touch current IB	—	—	✓	✓	—
Passive Testing					
Protective conductor resistance RPE	✓	✓	✓	✓	✓
Insulation resistance RISO	✓	✓	✓	✓	✓
Protective conductor current IPE (equiv. leakage current method)	—	✓	✓	✓	✓
Extension cables: the following additional measurements apart from RPE & RISO are conducted in switch position EL1					
single phase (3-pole)	✓	✓	✓	—	—
3-phase (5-pole)	—	✓	✓	—	—
wire short circuit	✓	✓	✓	—	—
wire interruption	✓	✓	✓	—	—
wire reversal	—	✓	✓	—	—

¹ Differential current method with SECUTEST PRO only
² for IPE and IG: AT3-IIS or, alternatively, AT3-II S32



Attention!

For information on the correct connection of test adapter and DUT as well as particular aspects during the test sequence please refer to the operating instructions of the test adapters.

Connection Example with EL1

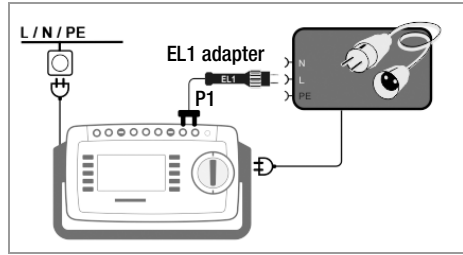

Connection Example with VL2E

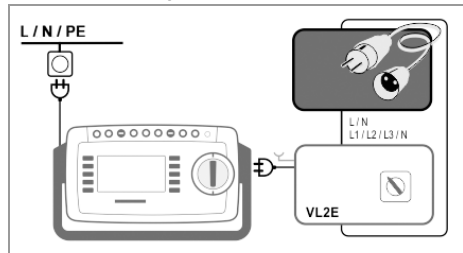

Connection Example for Protective Conductor Current Measurement IPE¹ (Direct Method) with AT3-III-E

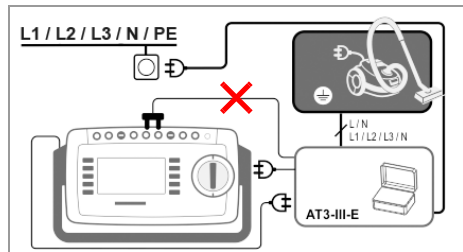

Connection Example for Device Leakage Current Measurement IG¹ (Differential Current Method) with AT3-III-E

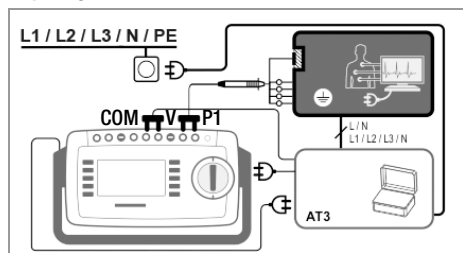











¹ with SECUTEST PRO and/or Feature IO1 or SECULIFE ST BASE(25) only

9 Test Sequences in Accordance with Standards

If the same sequence of single tests will be run frequently (one after the other with subsequent report generation), for example as specified in the standards, it's advisable to make use of test sequences. Limit values have been entered for test sequences in accordance with standards. And thus a go/no-go evaluation takes place during measurement based on worst-case assessment. If the momentary measured value is displayed in green, it lies within the limit values specified in the standard. If the measured value is red, it does not fulfill the requirements set forth in the standard. If the measured value is shown in **amber**, further entries are required. Even if the DUT fails just a single test step, the test sequence is aborted and testing in accordance with the selected standard is failed.



9.1 General Procedure

- 1 Select the desired test sequence with the rotary switch (**AUTO, A1 ... A8**).
- 2 If no test object has been selected, enter the ID number of the test object, for example by means of a barcode scanner, after selecting **ID**.
- 3 As an alternative to step 2, activate the database view with the **MEM** key: 
- 4 Select the test object with the scroll keys: 
- 5 Return to the measuring view by pressing the **ESC** key: 
- 6 Start the test sequence with the **START/STOP** key: 
- 7 The measured value recording symbol shown at the right appears.  Each time this key is pressed, the measuring or evaluation procedure is restarted (see case B in section 9.2).
- 8 Proceed to the next measurement by pressing the key shown to the right. 

- 9 At the end of the test sequence, you can generate a list of the results of the individual test steps. 
- 10 If you want to view details such as the settings for the individual test steps, select the desired measurement with the cursor and press the **+ magnifying glass** key. 
- 11 The display is returned to the list of test steps by pressing the **- magnifying glass** key. 
- 12 Save the results of a successful test sequence by pressing the **Save** key. 

9.2 Evaluation Procedure

The evaluation procedure can be started manually for some test steps within a given test sequence, but all others are run automatically.

- **Case A – automatic triggering of evaluation:** Evaluation (with a duration of, for example, 5 seconds) is started automatically as soon as the measured value has stabilized. The worst value which occurs during this duration is saved, and automatic switching to the next test step ensues.
- **Case B – manual triggering of evaluation:**  Evaluation is started after pressing the measurement value recording symbol (display: 0). After a specified period of time has elapsed, the worst value is saved to the right of **wc:** (worst case), and the number 1 is displayed in the measurement value recording symbol indicating that the first measured value has been saved. Pressing the measured value recording icon again restarts the evaluation procedure. If the worst value is worse than the value obtained for the previous measurement, the new value is used. However, if this value is better than the previous worst value, the original value remains in the display. Depending on whether you want to delete the last value saved to the clipboard or all values, press the symbol shown below an appropriate number of times. Proceed to the next test by pressing the symbol shown to the right. 

9.3 Sample Test Sequence

1 Select test sequence



A2

As-delivered Condition:

A1	VDE 0701-0702, passive meas. type, test socket
A2	VDE 0701-0702, active meas. type, test socket
A3	VDE 0701-0702, param. config. for EDP (active)
A4	IEC 62353 (VDE 0751), passive measurement type
A5	IEC 62353 (VDE 0751), active measurement type
A6	IEC 60974-4, connection type: test socket
A7	IEC 60974-4, connec. type: AT16-DI/AT32-DI adapter
A8	VDE 0701-0702, MT ExtCord, EL1/ML2E/AT3-IIIE adapter
AUTO	VDE 0701-0702, active measurement type, test socket

2 Open database

MEM

3 Select Device

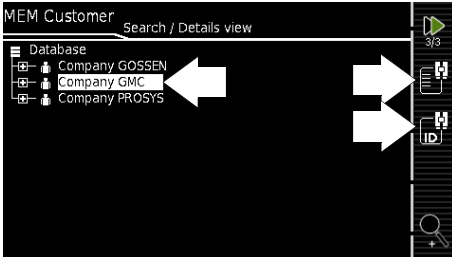

4 Switch to start view

ESC

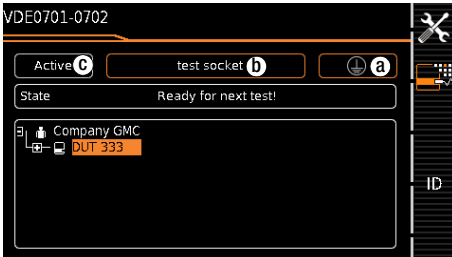

5 Sequence parameters



Individual test steps can be configured with the sequence parameters, see detailed operating instructions.

6 Set classification parameters



Switch setting: A1 ... A8

Meas. Parameter	Meaning
Protection class *	PC1/PC2/PC3
Connection type *	Test socket / permanent / adapter
Detected classification	No auto-detection: all classification parameters such as connection and protection class must be entered manually. Always accept: all classification parameters activated under "Auto-detection of" are detected automatically and accepted.
Auto-detection of	Any desired combinations for automatic detection of: – Connection – Protection class (SK)

AUTO switch setting

Meas. Parameter	Meaning
Standard	Test standard / extension cord
Protection class * (a)	PC1/PC2/PC3
Connection type * (b)	Test socket / permanent / adapter
Measurement type (MT) * (c)	Active or passive DUIT (on test: on = passive, off = active)
Detected classification	No auto-detection: all classification parameters such as connection, protection class and measurement type must be entered manually. Always accept: all classification parameters activated under "Auto-detection of" are detected automatically and accepted.
Auto-detection of	Any desired combinations for automatic detection of: – Connection (b) – Protection class (SK) (a) – Measurement type (MA) (c)

* If the configurations of the classification parameters are recognized automatically, they are marked with an amber frame (in this case (a) and (b)); as from firmware version V1.3.0). They must be entered manually if they're not automatically detected, or if they're detected incorrectly.

7 Connect DUT

- Connect the DUT to the test instrument in accordance with the selected test sequence.
 - Test socket
 - Permanent connection
 - Adapter

Switch position: A1 ... A7, AUTO

Connection depends on the type of DUT.

Switch position A8

For testing extension cords in accordance with standards: connection to the test socket via the following adapter:

- **EL1:** for single-phase extension cords
- **VL2E/AT3-IIIE:** for single- or three-phase extension cords

8 Check connection & start test sequence

The following checks are run automatically before the test sequence is started:



- Probe test P1 (whether or not the probe is connected and if fuse P1 is OK)
- Insulation test (whether or not the DUT is set up in a well-insulated fashion)
- On test and short-circuit test. In order to be able to detect a short-circuit at the DUT, testing is conducted between L and N, as well as LN and PE.

If you've set the "Detected classification"

parameter for the respective test sequence to "Always accept" and the "Auto-detection of" parameter to "Connection and SK" (before triggering **Start**), the following additional checks will be run before the test sequence is started:



- Protection class detection for DUTs with protective conductor
- Connection check: whether or not the DUT is connected to the test socket. In the case of protection class I: whether or not the two protective conductor terminals are short-circuited.

9 Manual evaluation of visual inspection

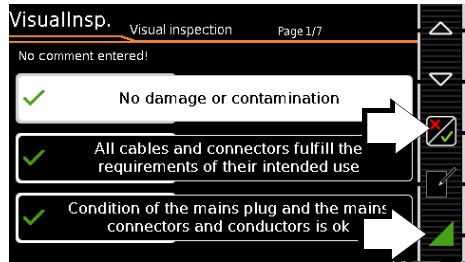

- ✓ Visual inspection passed
- ✗ Visual inspection not passed (sequence is aborted, test failed)
- ▲ Resume test sequence



Note!

If the plug is disconnected from the test socket during the test sequence, the sequence is immediately disconnected.

10 Test step – start evaluation

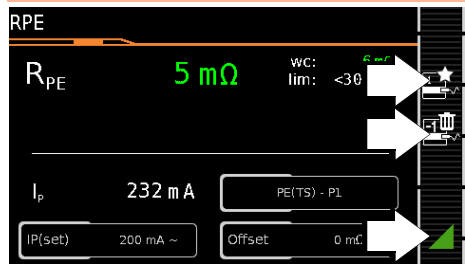

Green measured value: complies with standard

- Record measuring point.
- Delete last measuring point.
- ▲ Resume test sequence.

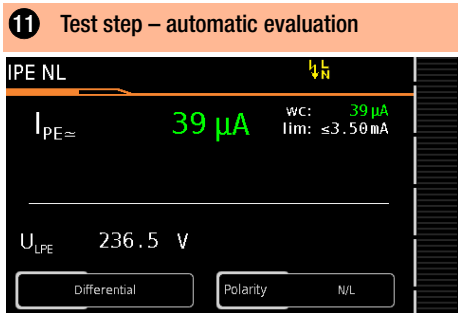

The measured value is ascertained automatically within a specified period of time. The test sequence is then automatically resumed.

Green measured value:
complies with standard

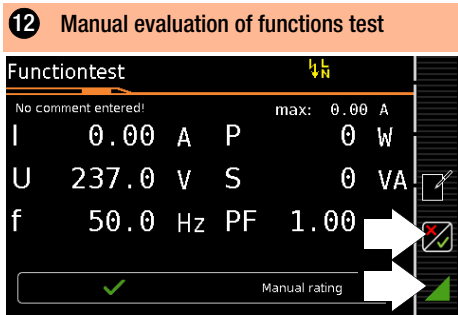

- Functions test passed
- Functions test not passed (sequence is aborted, test failed)
- Resume test sequence
- Remove DUT from service

Optional test step

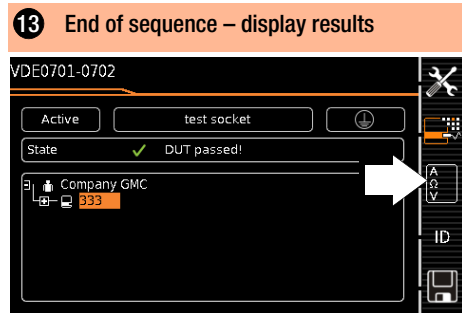

(display of the memory screen depends on the parameter pre-selection in the **SETUP** switch position:

Setup 1/3 > Auto. measurements > At end of sequence > **Memory screen**. If set to **events list**, **13** is omitted.)

Optional test step

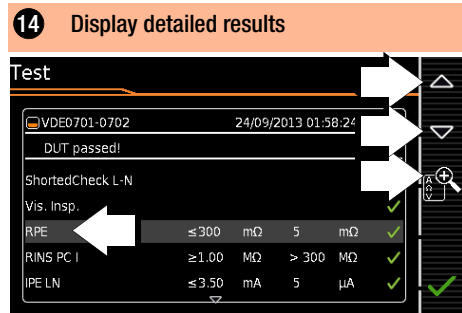

(consideration of measuring error depends on the parameter pre-selection for the **SETUP** switch setting: Setup 1/3 > Auto. measurements > Error considered. > **Yes**)

Optional test step

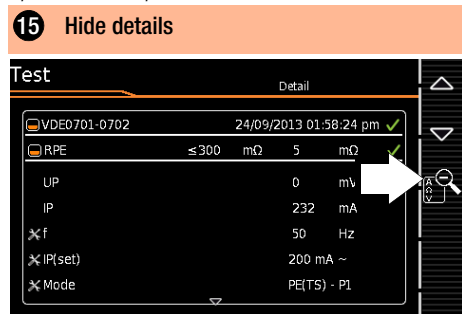

Optional test step

16 Confirm results

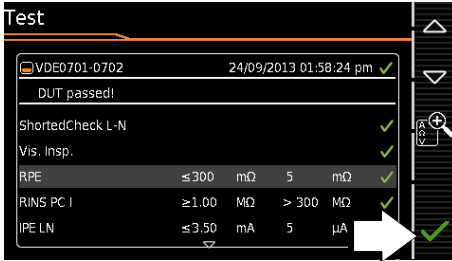

 Switch to memory screen

17 Save results under ID no.

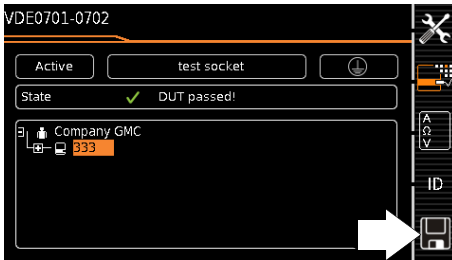

 Save results

or with feature **KD01 „Z853S – SECUTEST DB COMFORT“**:

1.  Send measurement data to the PC, via USB or Bluetooth® (Feature M01), e. g. for saving to the **IZYTRONIQ** report generating software (push-print function), description see online help for **IZYTRONIQ**

10 Measurement Parameters for Individual Measurements and Test Sequences

Measurement parameters which apply for both individual measurements and test sequences, have to be entered in selector switch position **SETUP**.

Setup 1/3 > All measurements

Meas. Parameter	Meaning
Meas. at IT-mains (Yes / No)	Yes: active leakage current measurements (and/or all measurements which include the PE at the mains connection end) are blocked. Test sequences which contain such kind of measurements are disabled as well.
Ref.voltage L-PE (110 V, 115 V, 220 V, 230 V, 240 V)	The reference (line) voltage is the voltage to which the measured values for leakage current have been standardized. It is used in the case of leakage current for mathematical adjustment of the current measuring values to the predefined voltage. Measurements with line voltage at the test socket: The setting value has no influence on the voltage with which the DUT is supplied via the SECUTEST test socket. Leakage current measurements with measurement type „Alternative“: The setpoint value of the synthetical test voltage is derived from the value specified here.
Testingfreq Alt (48 Hz ... 400 Hz)	Variable frequency setpoint value for synthetical test voltage for all leakage current measurements of measurement type „Alternative“, affecting the following measurements and/or rotary switch positions: <ul style="list-style-type: none"> – Individual measurements (green rotary switch level) – Measurements in test sequences predefined ex factory – Measurements in user-defined test sequences (only with database expansion Z853R or feature KB01)

**11 Repair and Replacement Parts Service
Calibration Center and Rental Instru-
ment Service**

If required please contact:

GMC-I Service GmbH
Service Center
Beuthener Straße 41
90471 Nürnberg, Germany
Phone: +49 911 817718-0
Fax: +49 911 817718-253
e-mail service@gossenmetrawatt.com
www.gmci-service.com

This address is only valid in Germany. Please contact our representatives or subsidiaries for service in other countries.

12 Product Support

If required please contact:

GMC-I Messtechnik GmbH
Product Support Hotline
Phone, +49 911 8602-0
Fax: +49 911 8602-709
e-mail: support@gossenmetrawatt.com

13 Database Software

List of Device Variants with Software Variants

	Article-number	Software Variants		
		BUSINESS Starter	BUSINESS Advanced	BUSINESS Professional
Standard Models				
SECUTEST BASE IQ	M705A	•		
SECUTEST PRO IQ	M705C	•		
SECUTEST PRO BT comfort IQ	M705E	•		
SECULIFE ST BASE IQ	M693A	•		
SECULIFE ST BASE25 IQ	M693B	•		
Device Sets				
STARTER PACKAGE SECUTEST BASE IQ	M706A		•	
MASTER PACKAGE DB+ IQ	M706D			•
PROFI PACKAGE SECUTEST PRO IQ	M706M			•
COMFORT PACKAGE SECUTEST PRO IQ	M706V			•
WELDING PACKAGE SECUTEST PRO	M706P			•
3-PHASE CURRENT PACKAGE SECUTEST PRO IQ	M706S			•

IZYTRONIQ is a test software that has been newly developed from scratch. It enables the user to visualize and manage the entire testing procedure for all our test instruments and to document it in an audit-proof manner. For the first time, it is thus possible to combine the test and measurement data from a great variety of test instruments and multi-meters in one test and generate one report thereof. The intuitive user guidance and modern design provide for quick access to all functions.

The software is available in different sizes and versions for trades, industry and vocational training purposes.

Edited in Germany • Subject to change without notice • PDF version available on the Internet

 **GOSSEN METRAWATT**

GMC-I Messtechnik GmbH
Südwestpark 15
90449 Nürnberg, Germany

Phone: +49 911 8602-111
Fax: +49 911 8602-777
e-mail: info@gossenmetrawatt.com
www.gossenmetrawatt.com